

Алматы (7273)495-231
Ангарск (3955)60-70-56
Архангельск (8182)63-90-72
Астрахань (8512)99-46-04
Барнаул (3852)73-04-60
Белгород (4722)40-23-64
Благовещенск (4162)22-76-07
Брянск (4832)59-03-52
Владивосток (423)249-28-31
Владикавказ (8672)28-90-48
Владимир (4922)49-43-18
Волгоград (844)278-03-48
Вологда (8172)26-41-59
Воронеж (473)204-51-73
Екатеринбург (343)384-55-89

Иваново (4932)77-34-06
Ижевск (3412)26-03-58
Иркутск (395)279-98-46
Казань (843)206-01-48
Калининград (4012)72-03-81
Калуга (4842)92-23-67
Кемерово (3842)65-04-62
Киров (8332)68-02-04
Коломна (4966)23-41-49
Кострома (4942)77-07-48
Краснодар (861)203-40-90
Красноярск (391)204-63-61
Курск (4712)77-13-04
Курган (3522)50-90-47
Липецк (4742)52-20-81

Магнитогорск (3519)55-03-13
Москва (495)268-04-70
Мурманск (8152)59-64-93
Набережные Челны (8552)20-53-41
Нижегород (831)429-08-12
Новокузнецк (3843)20-46-81
Новый Уренгой (3496)41-32-12
Новосибирск (383)227-86-73
Омск (3812)21-46-40
Орел (4862)44-53-42
Оренбург (3532)37-68-04
Пенза (8412)22-31-16
Петрозаводск (8142)55-98-37
Псков (8112)59-10-37
Пермь (342)205-81-47

Ростов-на-Дону (863)308-18-15
Рязань (4912)46-61-64
Самара (846)206-03-16
Санкт-Петербург (812)309-46-40
Саратов (845)249-38-78
Севастополь (8692)22-31-93
Саранск (8342)22-96-24
Симферополь (3652)67-13-56
Смоленск (4812)29-41-54
Сочи (862)225-72-31
Ставрополь (8652)20-65-13
Сургут (3462)77-98-35
Сыктывкар (8212)25-95-17
Тамбов (4752)50-40-97
Тверь (4822)63-31-35

Тольятти (8482)63-91-07
Томск (3822)98-41-53
Тула (4872)33-79-87
Тюмень (3452)66-21-18
Ульяновск (8422)24-23-59
Улан-Удэ (3012)59-97-51
Уфа (347)229-48-12
Хабаровск (4212)92-98-04
Чебоксары (8352)28-53-07
Череповец (8202)49-02-64
Чита (3022)38-34-83
Якутск (4112)23-90-97
Ярославль (4852)69-52-93

Россия +7(495)268-04-70

Казахстан +7(7172)727-132

Киргизия +996(312)96-26-47

<https://amiad.nt-rt.ru> || afv@nt-rt.ru

AMIAD Water Systems

AMF² MICROFIBER FILTERS AMF²-93K

Serial number: _____

Order number: _____

Catalog number: _____

Filtration degree: _____

Tested by: _____

Cassettes Replacing Guide

AMIAD Water Systems

AMF²-93K Cassettes Replacing Manual

This document describes the process of replacing damaged cassettes in Amiad's AMF 93K micro-fiber filter and it contains the following sections:

- A. General information and safety instructions
- B. Preparing the filter for cartridge disassembly
- C. Removing the cartridge out of the filter's housing
- D. Disassembling the cartridge and replacing the damaged cassettes
- E. Reassembling the cartridge
- F. Reassembling the filter
- G. Restarting the filter
- H. Cassette Package explosion assembly drawings

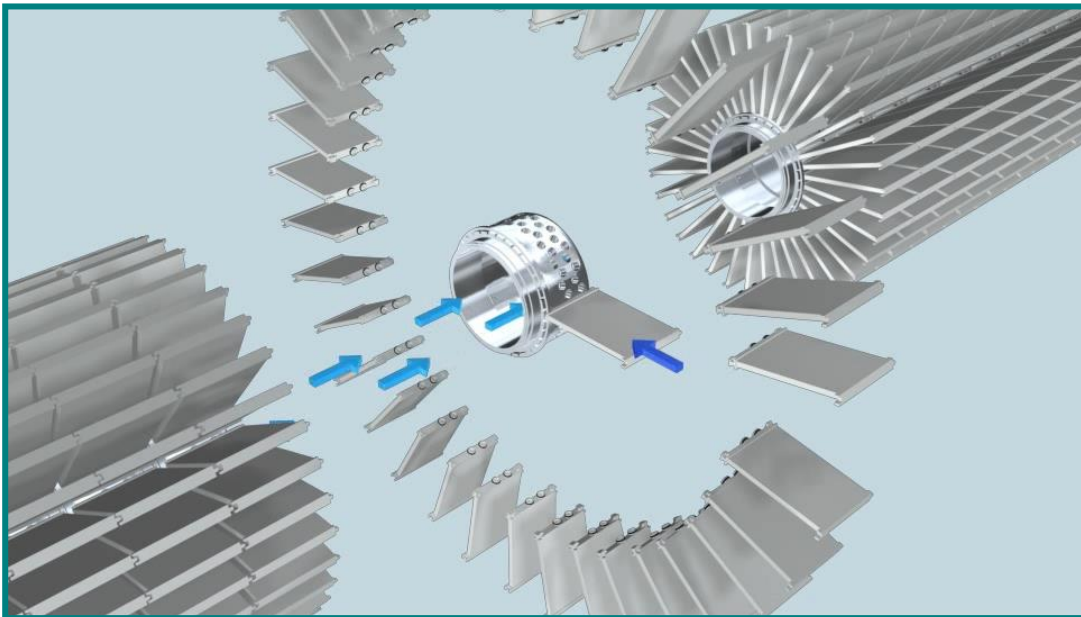

A. General Information and Safety Instructions:

Before you begin – Safety instructions

- Prior to installation, operation, maintenance or any other type of action done on the filter, read carefully the installation and operation instructions.
- During installation, operation or maintenance of the filter, all conventional safety instructions should be observed in order to avoid danger to workers, the public or to property in the vicinity.
- Please note: The filter enters automatically without any warning into a flushing mode.
- No changes or modification to the equipment are permitted without a written notification given by the manufacturer or by its representative on his behalf.
- Service the filter according to the detailed Instructions provided with the filter by the manufacturer and according to the description given in this manual.
- Electric wiring should be performed by an authorized electrician only, using only standard and approved components.
- If due to site constrains the control panel is installed with no line-of sight with the filter an additional Power Cut-off Switch should be installed near each filter unit before any attempt to service the filter is done.
- Extra safety devices should be installed on hot water applications to avoid skin burn danger.
- Disconnect the filter from power supply before performing any service, maintenance or any non-regular operation action.
- Loosening or unscrewing bolts should be done only after the pressure in the filter had been released.
- Avoid splashing and water leaking so as to minimize slipping, electrifying or damage to the equipment, caused by moisture.
- Always open and close valves slowly and gradually.
- Remove grease and fat material residues in order to avoid slipping.
- Re-assemble any protection covers or protection mechanisms removed during service or maintenance operations before re-operating the filter.
- Manual cleaning of filter media using high water pressure or steam should be performed in accordance with the cleaning system instructions and without endangering the operator or the vicinity.
- Manual cleaning of any filter element using acid or other chemical agents should be performed in accordance with the relevant material safety instructions and without endangering the operator or the vicinity.
- While using lifting equipment, make sure that the filter or the lifted part is chained securely and in a safe manner.
- Do not leave lifted equipment if there is no necessity.
- Avoid working below lifted equipment.
- Wear a safety helmet while using lifting equipment.
- Arrange suitable lighting at the area of the filter to enable good visibility and safe maintenance.
- Provide suitable platforms and safety barriers to enable easy access to the filter without climbing on pipes and other equipment.
- Check and re-tighten all bolts after finishing the maintenance or service work.
- Always maintain regular safety instructions and good engineering practices while working in the filter's vicinity.

Required tools:

In addition to a regular standard tool box, 2 special tools are required for a successful completion of the cassette replacing process:

1. MTG/AMF grooved Cassette Alignment Ring - catalogue number – 65-8040--4004

2. MTG/AMF Cassette Holder Ring - catalogue number – 65-8040--4001

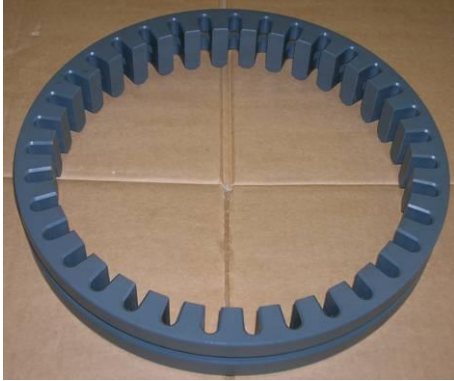

1 - MTG/AMF Cassette Alignment Ring



2 - MTG/AMF Cassette Holder Ring

Please contact your supplier for ordering these tools.

Understanding the cartridge cassettes' arrangement:

Important Note:

Prior to performing the actual work it is very important to understand the special arrangement of the cassettes in the filter's cartridge! Improper assembly of the cartridge will lead to filter malfunction and to a significant damage!

Two types of cassettes are used in the cartridge:

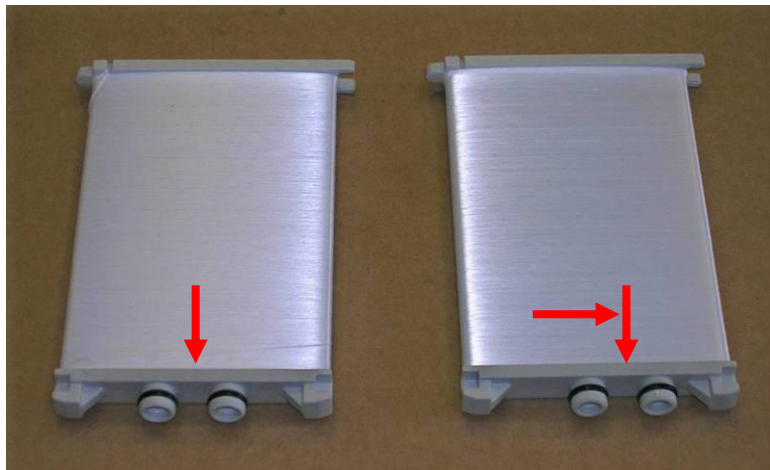

1. Centralized nipples cassette type (as appears at the picture's right side)
2. Shifted nipples cassette type (as appears at the picture's left side)

Make sure that you have the correct spare parts before disassembling the cartridge.

35 cassettes are connected to a single joined-in collector pipe and form a package. The connector holes in the join-in connector are arranged so the two types of cassettes are used alternatively:

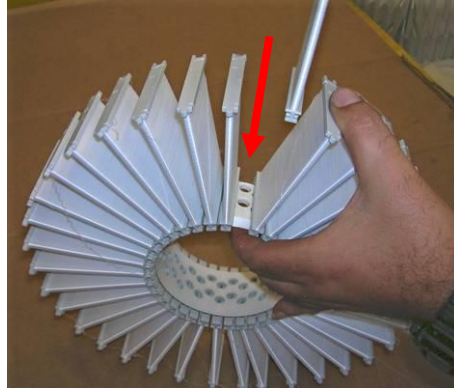

Please note that the missing cassette in the above picture is a shifted nipples cassette.
See also the alternating arrangement of the holes in the internal part of the join-in connector unit.

Opposite to the connector nipples, at the outer edge of the cassette, two U shape connectors are found. One of these connectors is of a female type and the other is a male type.

34 of the cassettes in each package are arranged with the male connector pointing to the same direction while the 35th cassette is mounted in the opposite way where its female connector is pointing to the direction of the other cassettes male connectors.

The 35th cassette serves as the Leading Cassette and during the assembly process of the cartridge it is very important to position it in the right location as explained further down in this manual.

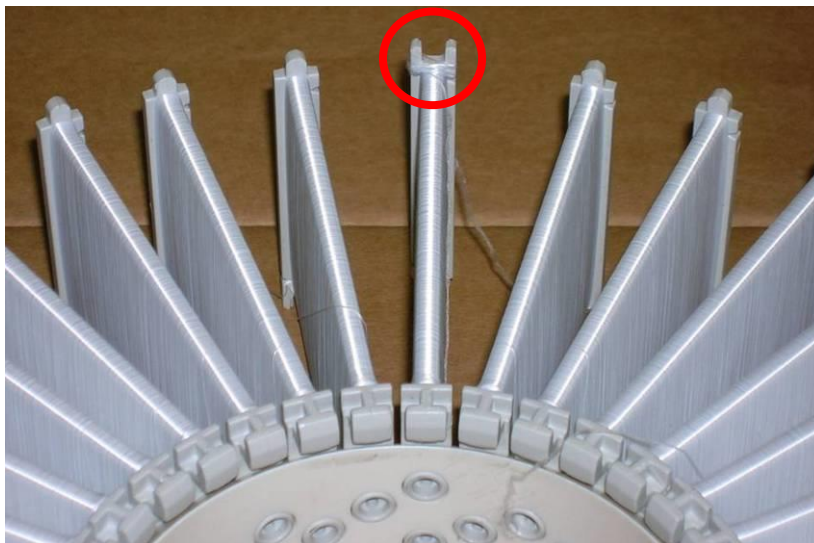

Please note that **the upper middle cassette in the above picture is the Leading Cassette** of the package. Please see that the other cassettes male connectors are pointed up while the Leading Cassette is in the opposite direction.

26 packages are attached to each other surrounding a Central Pipe assembly and form a cartridge.
The packages are attached to each other where their Leading Cassettes are aligned together to form the central axis of the cartridge. The cartridge central axis is aligned with marking holes in the other parts of the complete cartridge.

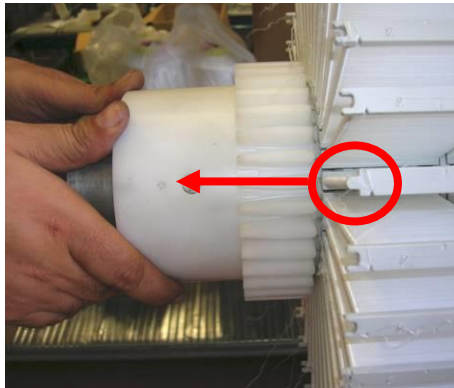

In the above picture you can see how the Leading Cassette (shown in the middle of the picture) is aligned with the marking hole on the cog-wheel.



The above picture shows how the Leading Cassettes are connected together along the cartridge and perfectly aligned with the markings of the other parts.

B. Preparing the filter for cartridge disassembly:

1. Disconnect the filter from the process water system by closing the upstream (the entry point of unfiltered water to the filter) and downstream (the exit point of clean water from the filter) manual valves.
2. Drain the filter housing by manually opening the drainage butterfly valve located at the lower side of the filter body.



3. Make sure that Piston#40 is pushed out of the cartridge to ensure that the spray nozzles are not within the cassette package limits:
 - i. Remove the plug from the flange of the tail assembly.
 - ii. Insert a clean and straight 4.5 meter 0.5" pipe or rod (the Tune-up rod) through the opened connection.
 - iii. Using the rod push the piston all the way in.
 - iv. Remove the rod out of the filter and reassemble the plug.

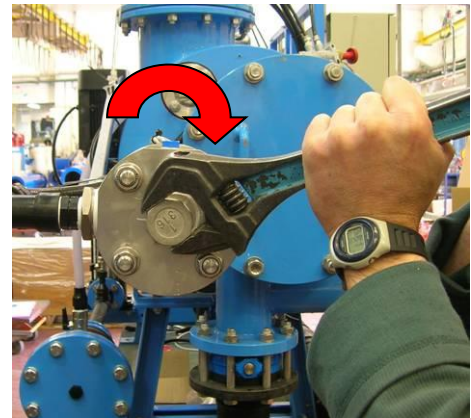
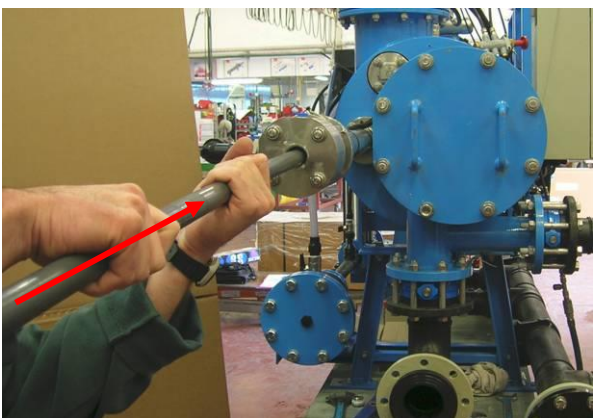

- i. Properly mark the upper and lower 8mm water control tubes and disconnect them from the Index Piston. **Important: Mistakenly re-assembling these control tubes may cause serious malfunction of the filter.**
- ii. Connect a compressed air tube to the lower port of the Index Piston to push the piston to its "Out" position. This will allow you to freely rotate the cartridge as required at stage C.1.8. Leave the Index Piston locked at this position till the end of the cassette replacement process.

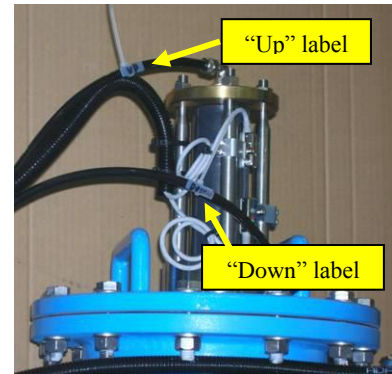
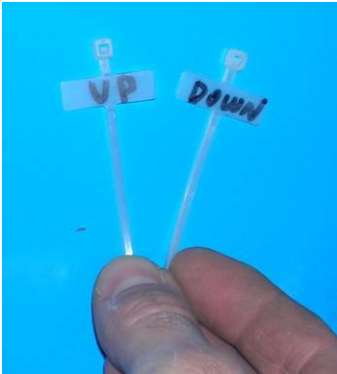

C. Removing the cartridge out of the filter's housing:

C.1. Identifying the damaged cassettes:

1. Disconnect the High Pressure Pipe from the far end of the Piston House Assembly.

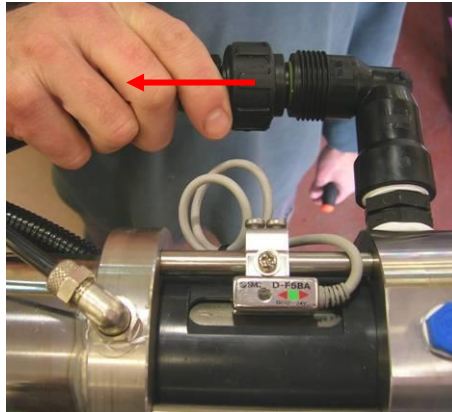

2. Disconnect the control tube from the Piston House Assembly.

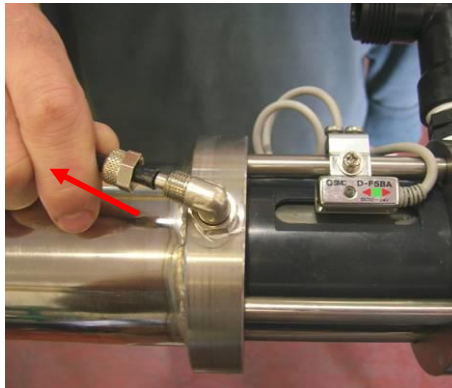

Disconnect the Proximity Switch SW1 from the Piston House Assembly by unscrewing the sensor from its Mounting block.

Important note: Make sure that the Mounting Block of SW1 stays in its current position! Any movement of the block will affect the piston's calibration and will cause damage to the filter. Only the sensor should be removed!!!

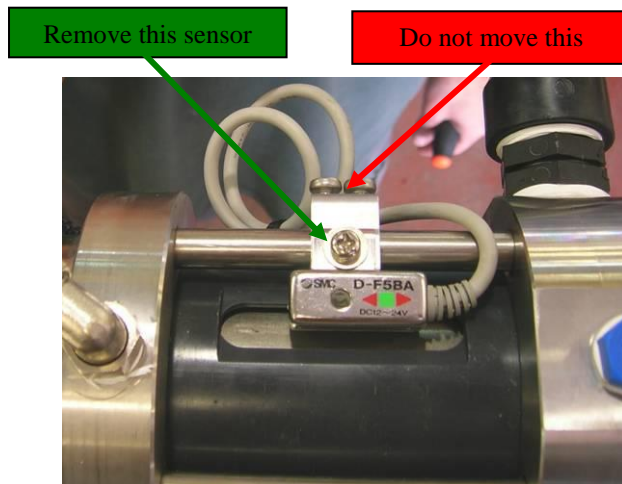
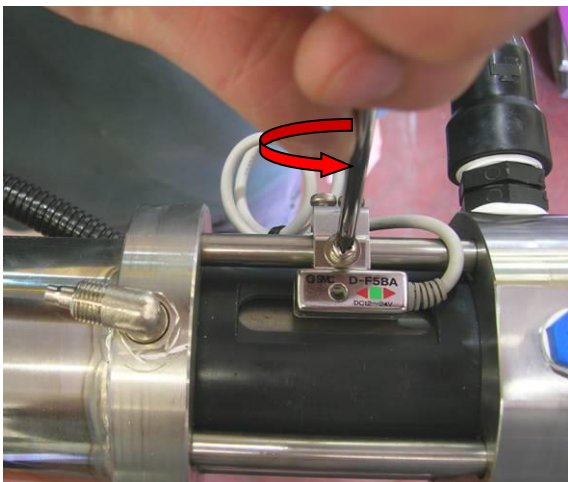

Don't Move this Block

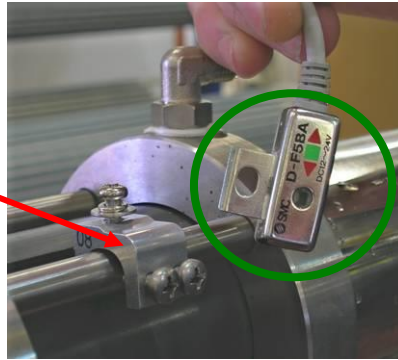

3. Unscrew the filter's Intermediate Cover bolts and open the Cover by gently pulling it out together with the Piston Hosing and the Piston#50 Assemblies. (Hold the Cover Handle with one hand (1) and support the Piston Housing with your other hand (2).)

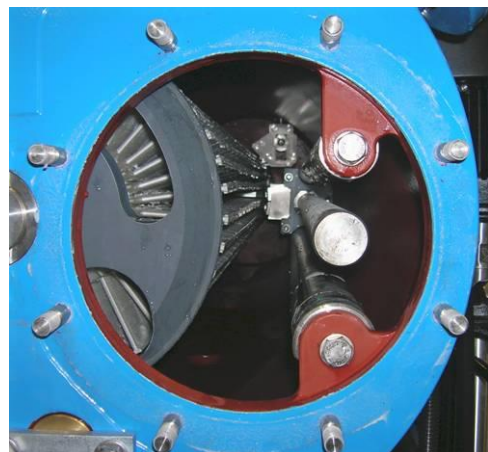
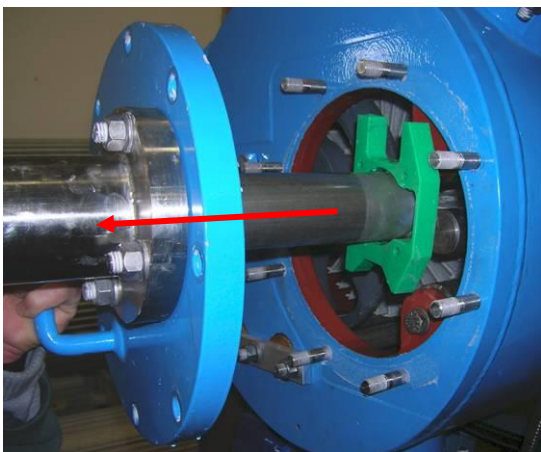
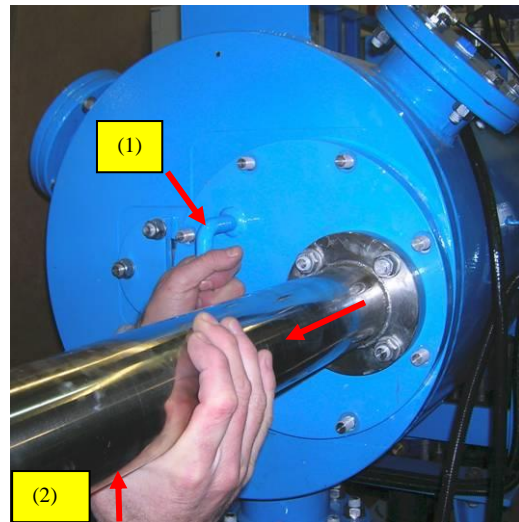
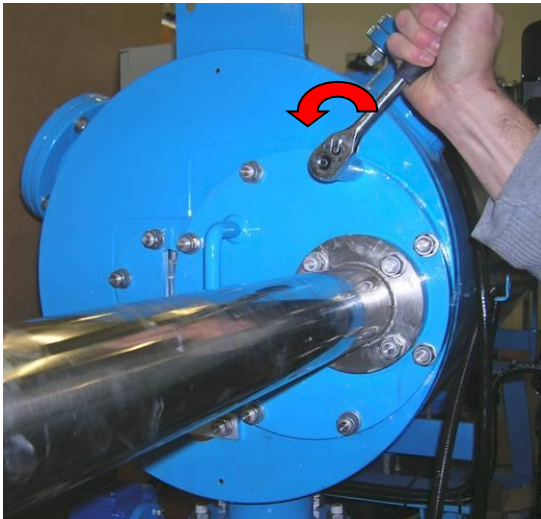

4. Make sure that the V-Shape Plate of the cartridge points to the central line of the filter, if necessary turn it by hand accordingly (1). Remove Piston#40 by pulling it straightly but gently out of the filter. Make sure not to damage the cassettes by letting the spray nozzles to hit the cartridge (2) while pulling the piston (you may need assistants to keep the piston balanced while pulling it out of the filter).

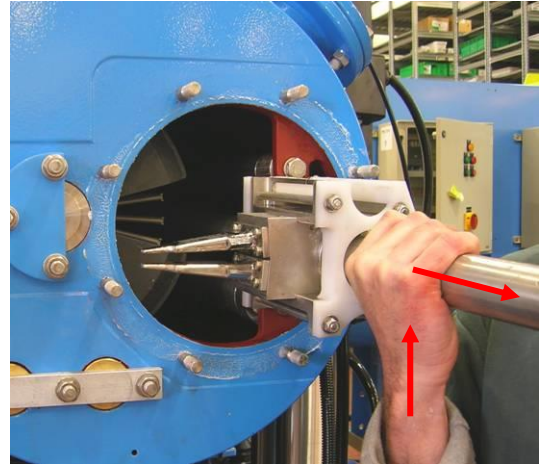
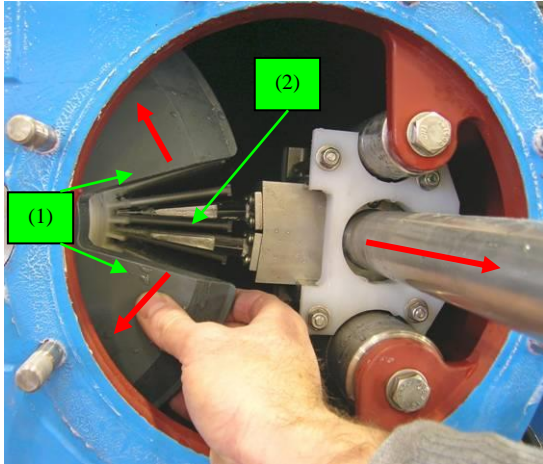

5. Using a flashlight inspect the interior of the filter for damaged cassettes. Firmly hold the nozzle guide Cog-Wheel and rotate the cartridge till all the cassettes' rows are checked. If damaged cassettes are found please continue with the cartridge removal procedure.

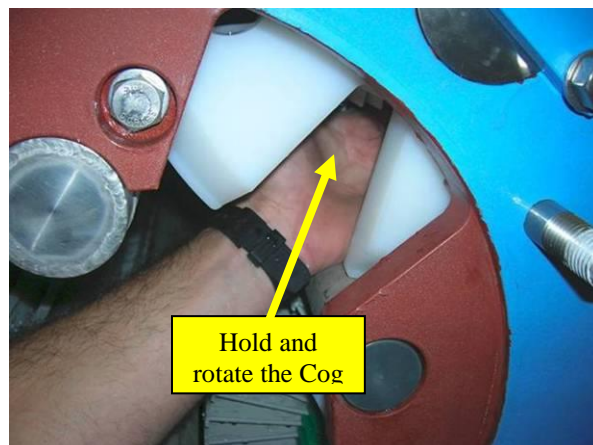

- ✚ **Important note:** In case it is too difficult to rotate the cartridge by hand, operate the Index Piston by alternating the compressed air tube connection. Connect the tube to the upper port to move the index by one row and reconnect the tube to the lower port to advance the index by another row. Continue this operation till all the cartridge rows are checked for damaged cassettes.

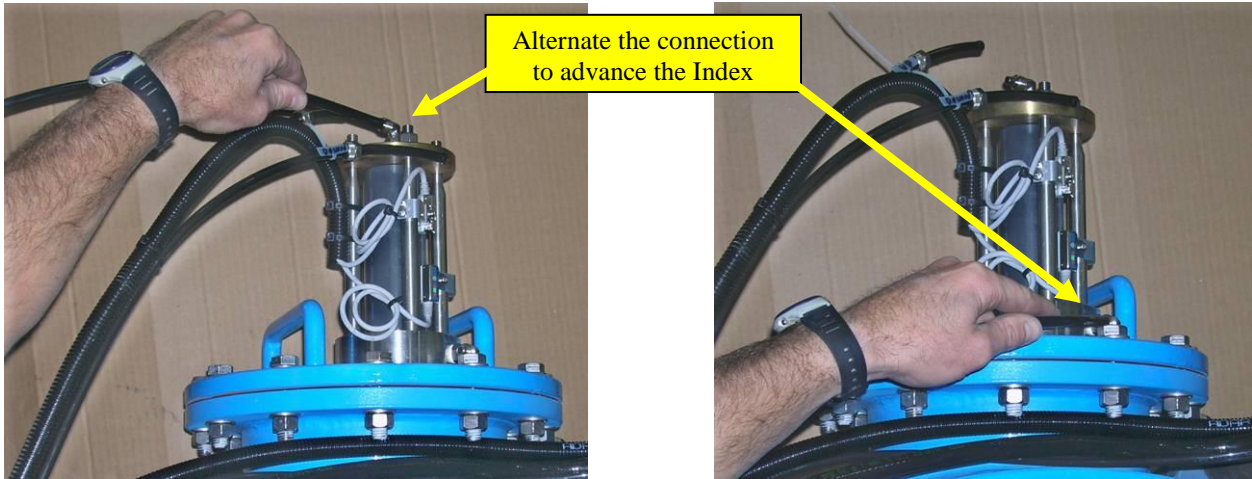

C.2. Removing the cartridge with the damaged cassettes:

1. Make sure that the Index Piston is forced out of the cartridge (See stage B4 for details). Prior to the removal of the cartridge out of the filter housing it is necessary to force the Index Piston out of the Gear Turn cog-wheel. **Any attempt to pull out the cartridge while the Index Piston is "in" will cause damage.** Verify that the Index Piston is locked at the "out" position by checking the proximity switch. The Index piston has two switches; the closer one to the filter housing indicates that the piston is "in", while the farthest switch indicates that the piston is "out". Make sure that the green led of the farthest switch is lighted up.

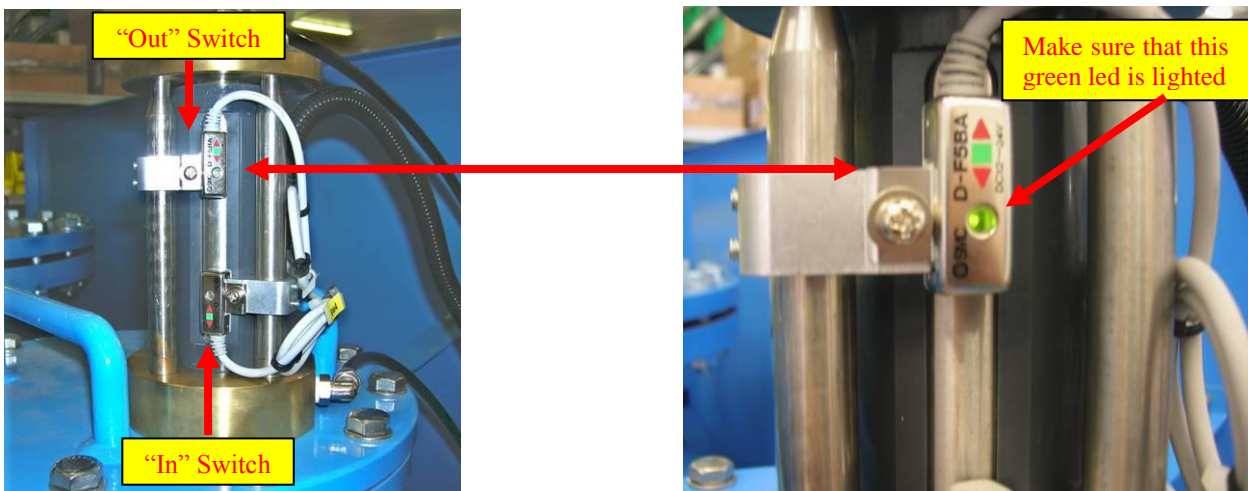

2. Unscrew the bolts and remove the cartridge lid. (You may need assistance since the lid may be heavy for one person to carry so take an extra care!)

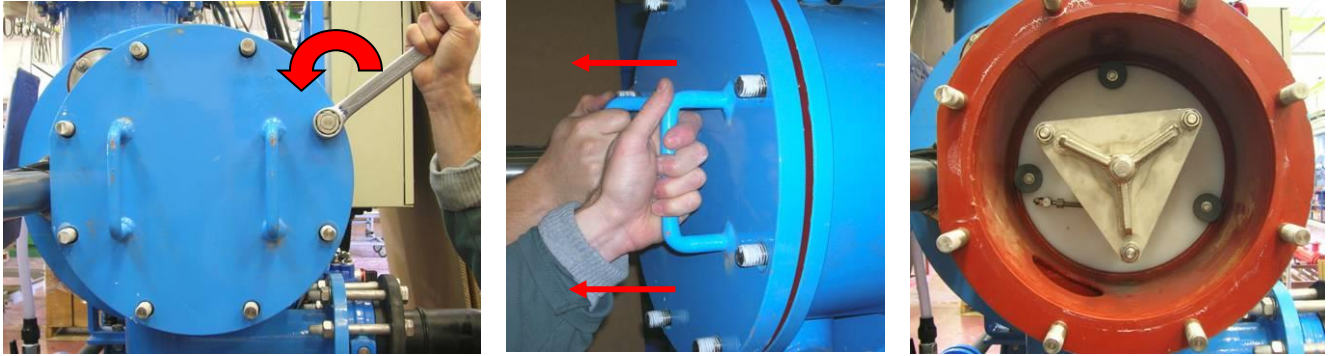

3. Unscrew and release the bolts of the three disc stoppers (1), turn each one of the stoppers by 180° and make sure that they are not extended beyond the borders of the Plate Partition (2).

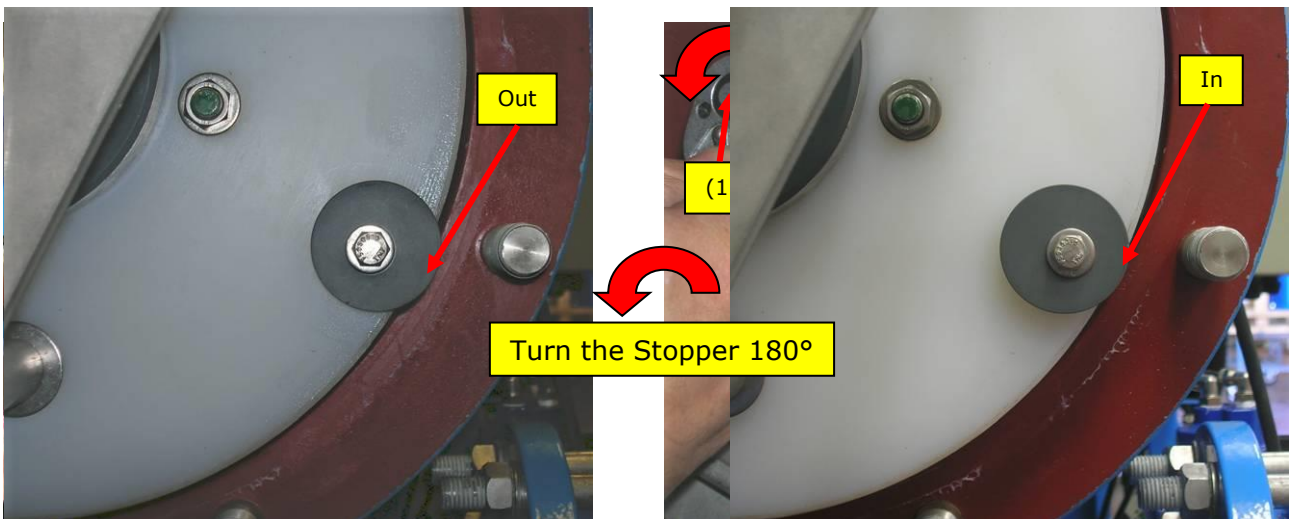

4. Hold the cartridge Triangle Plate and start to pull the cartridge out of the filter housing (1). Once the cartridge is released and starts to move, lift it slightly with one hand and continue to pull it out with the other hand till the first Cassettes' Package passes the opening (2), then continue to pull out the cartridge in a straight line (3).

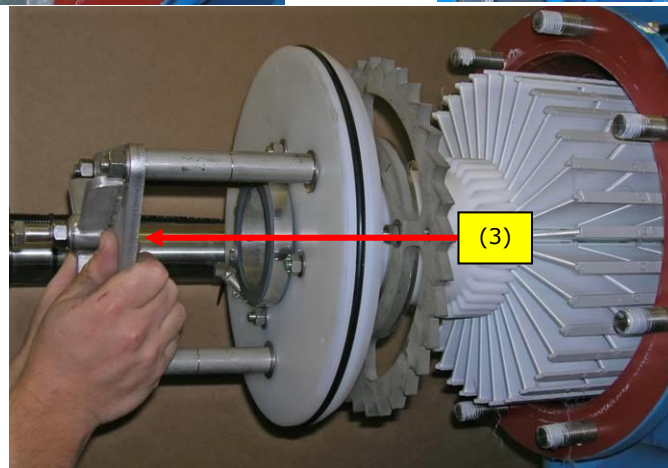
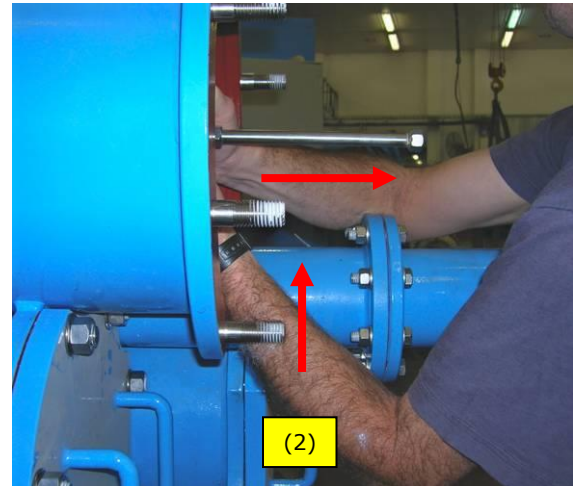
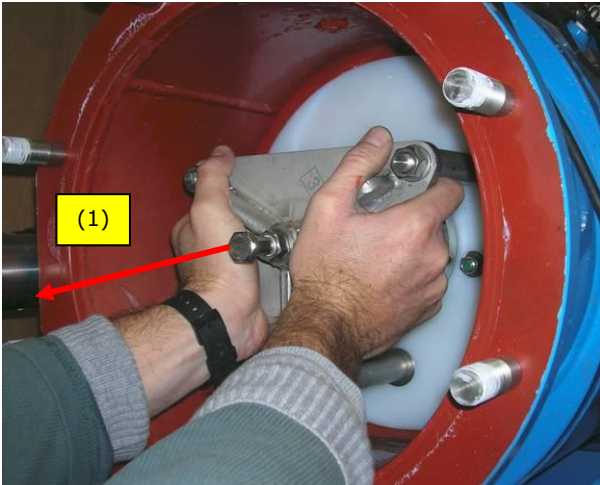

5. With a help of an assistant pull the cartridge out of the filter housing and gently put it on some support where the cassettes do not touch the ground.

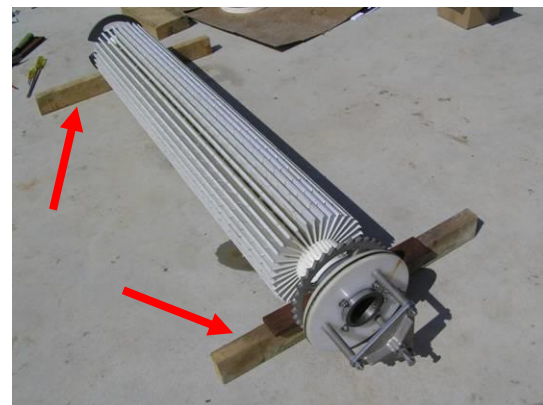
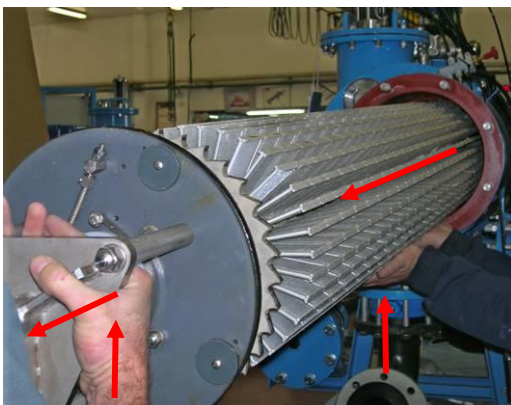

D. Disassembling the cartridge and replacing the damaged cassettes:

1. Unscrew and remove the 4 Self Tapping Screws from the Nozzle Guide cog-wheel.

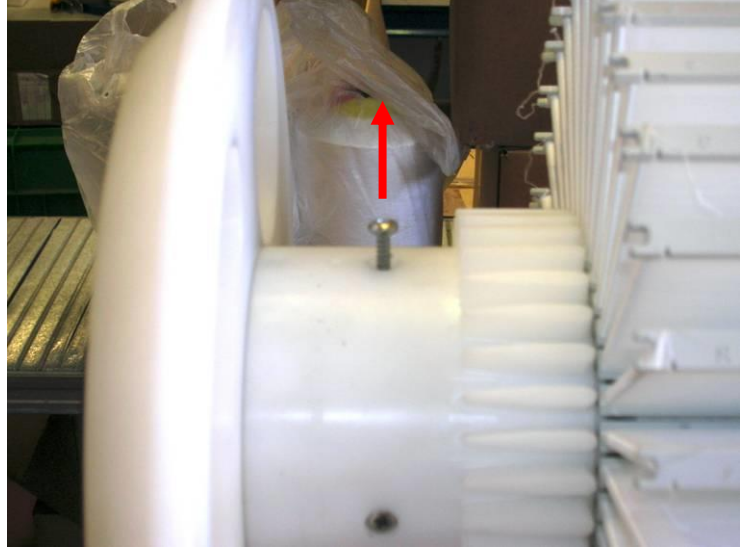
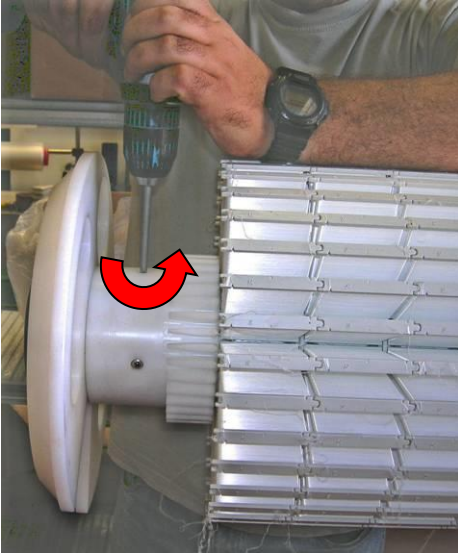

2. Remove the Guide Plate from the Central Pipe using a hammer and soft-edge plastic or wooden stake.

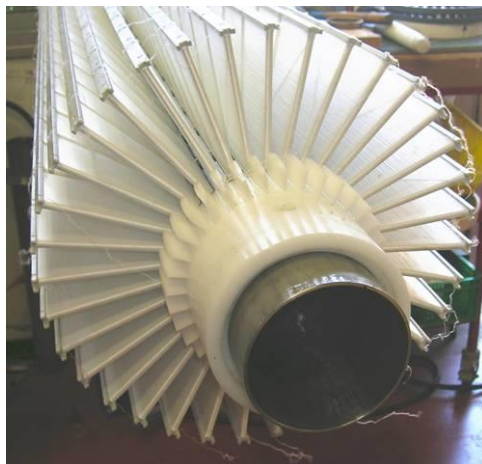

3. Use a screwdriver to gently release the Nozzle Guide cog-wheel from the first Cassette Pack and pull it out of the Central Pipe.

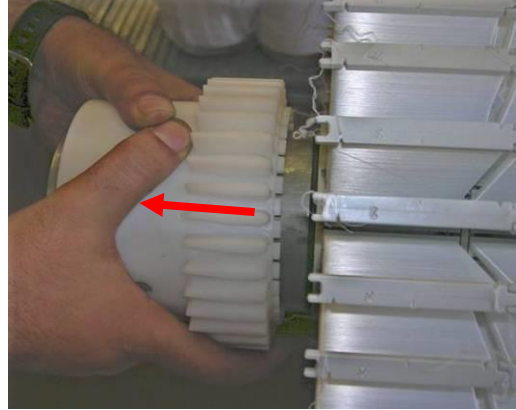
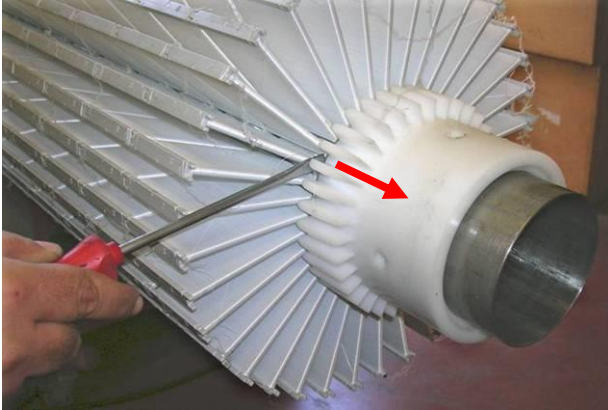

4. Use a screwdriver to gently release the 2 O-ring seals from the Half Cassettes Connector

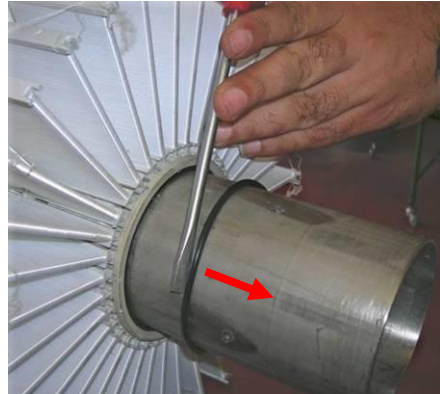
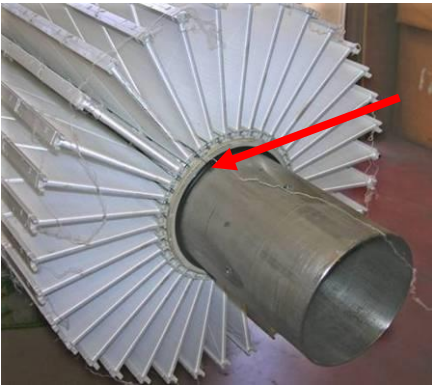

5. Use a screwdriver and gently release the Half Cassettes Connector from the first Cassette Pack, then pull the connector out of the Central Pipe.

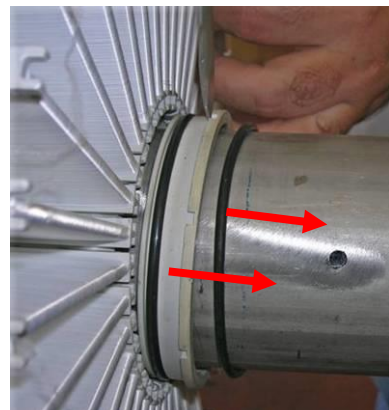

6. Hold the first Cassette Package with both arms, pull it out of the Central Pipe and put it gently on a clean surface.

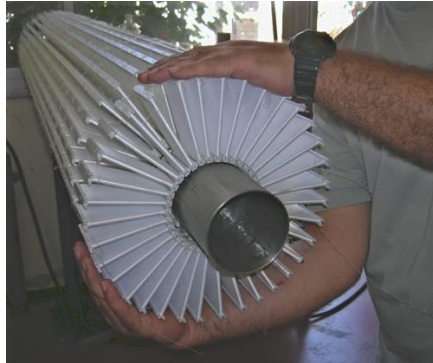

7. Use a screwdriver or a bended steel wire to gently pull out and release the two locking pins of the Cassettes Connector out of their holes in the Central Pipe. Pull out slightly the Cassettes Connector and turn it clockwise to eliminate the pins to be trapped again by holes on the Central Pipe. Pull the Cassettes Connector and remove it of the Central Pipe.

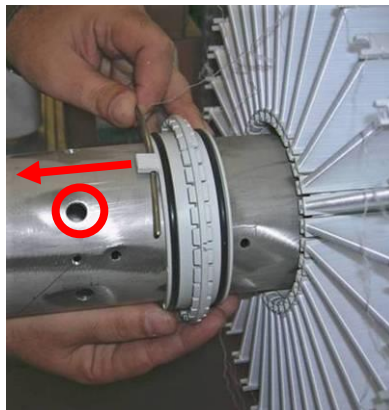
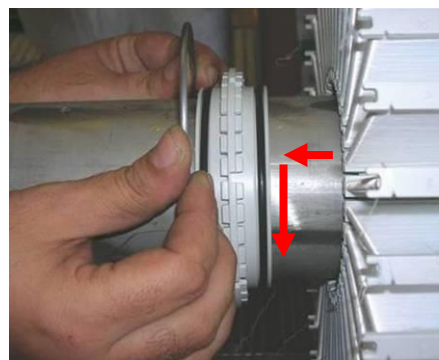

8. Hold the second Cassette Package with both arms, pull it out of the Central Pipe and put it gently on a clean surface.



9. Unscrew and remove from the Central Pipe 2 Machine Screws located between Cassette Packages 2 and 3.

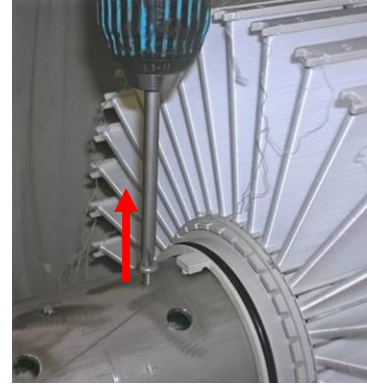
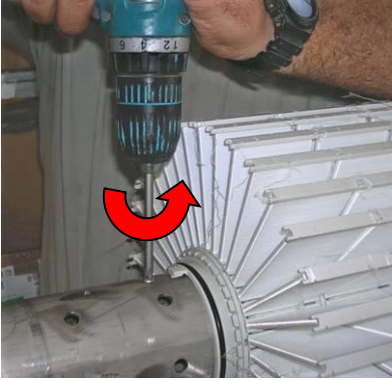

10. Repeat steps 7-8 and remove all the Packages that contain damaged cassettes. Please note that if there are damaged cassettes in the far end of the cartridge you will have to repeat step number 9 and remove the 2 Machine Screws located between Cassette Packages number 25 and 26.

11. Pull out any damaged cassette and insert a new one in its place. Firmly press in the new cassette and check that its connection nipples are fully inserted to the Join-in Connector Unit. It is very important to make sure that the new cassette's type (Centralized or Shifted Nipples) and filtration degree remain the same as of the original cassette.

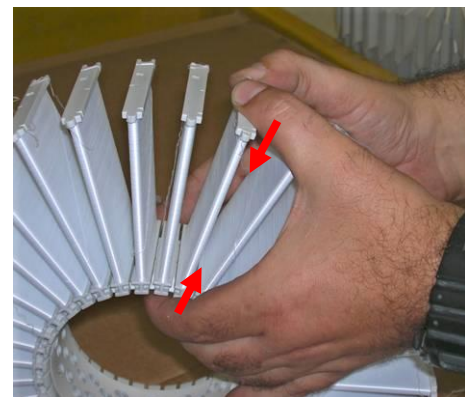
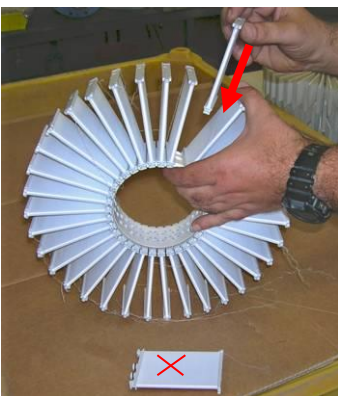
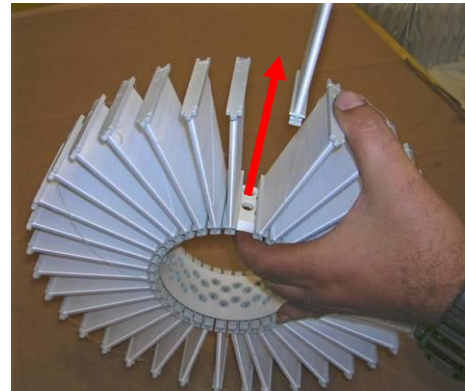
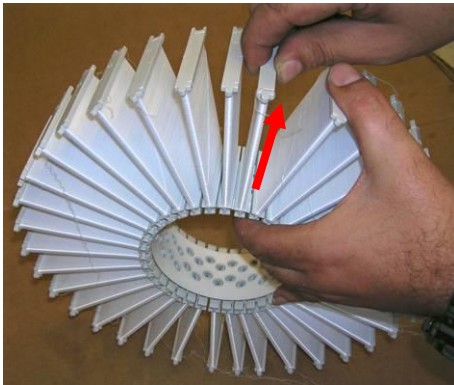

E. Reassembling the cartridge:

1. Insert the Cassette Alignment Ring over the Central Pipe and locate it on the last installed Cassettes Package. While pushing the ring to its place make sure that all the cassettes are inserted to their respective grooves in the Alignment Ring. Once all the cassettes are in the grooves gently push-in the ring few more centimeters and locate it at the far end of the first package close to the point where the package is connected to the previous one.

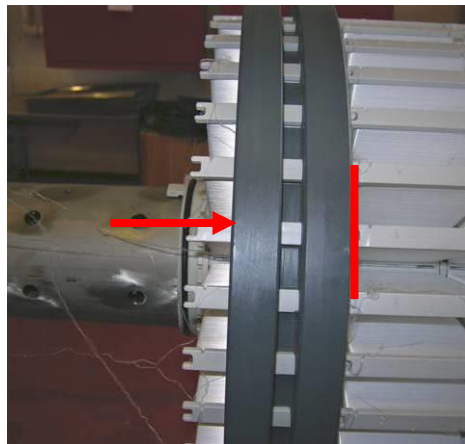
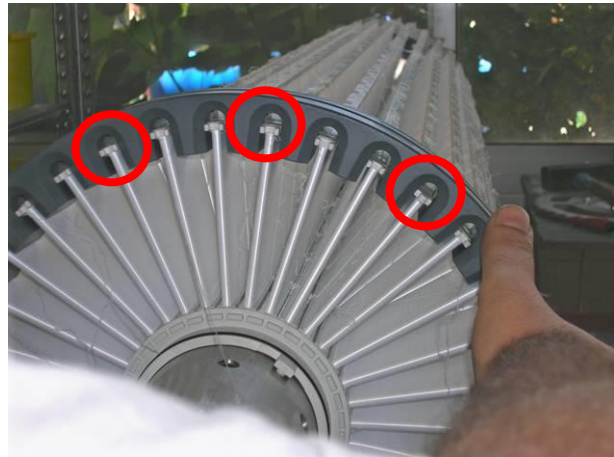
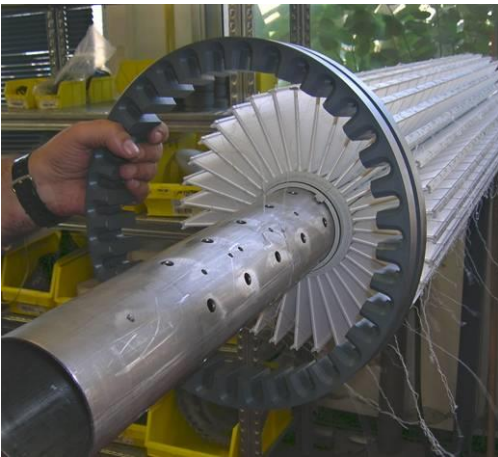

2. Insert a new Cassettes Package over the Central Pipe. Make sure that the female U-shape connector of the Leading Cassette is pointing forward to the central alignment line created by the Leading Cassettes of the previously installed packages.



3. Locate the new Cassettes Package close to the previously installed one and verify that the Leading Cassettes of the two packages are aligned with each other. (Look at the red circle in the following picture and notice how the Leading Cassette with the female U-shape connector pointing to the right, is aligned with the previous Leading Cassette with the male U-shape connector pointing to the left.)

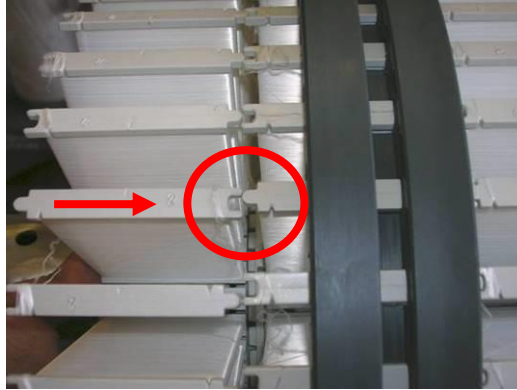

4. Pull the Cassette Alignment Ring few centimeters backward and locate it so it covers the U-shape connectors of both cassettes packages.

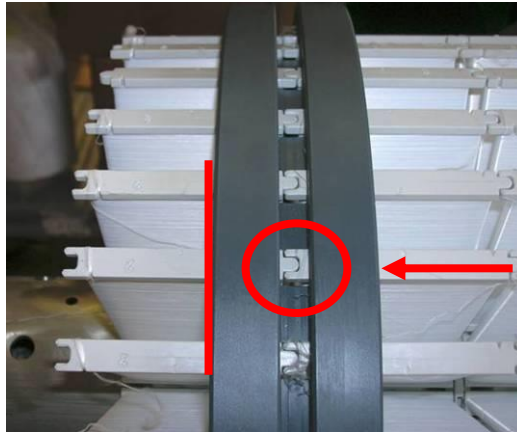

5. Insert the Cassette Holder Ring over the Central Pipe and use it to push the Cassettes Package till the U-shape connectors of the last two Packages are firmly joined together.

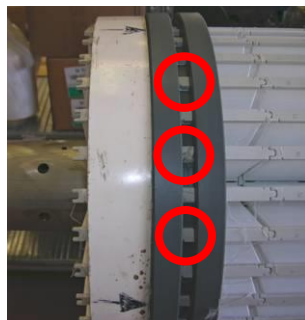
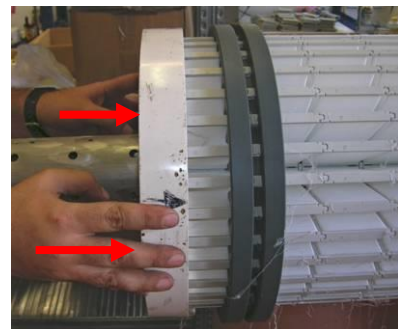
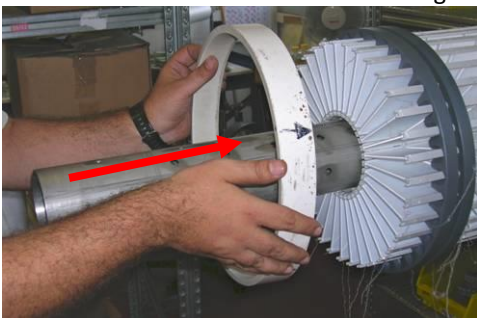

6. Insert a Cassettes Connector over the Central Pipe. Make sure that its two locking pins are pointed backwards and located between two rows of the Central Pipe holes (Otherwise they will be trapped by the wrong holes once you push the connector to its place). Push-in the connector till it reaches the last hole before the Cassettes Package. Turn it contra clockwise till the locking pins are aligned with their designated holes. Finley push the connector to its place, position its locking pins over their respective holes and push them down till they are firmly locked.

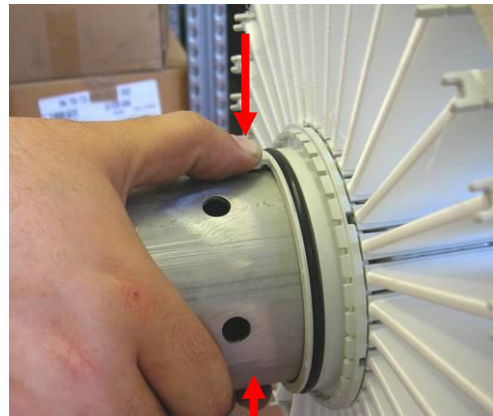
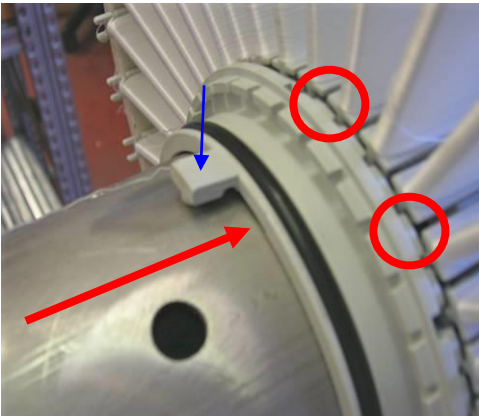
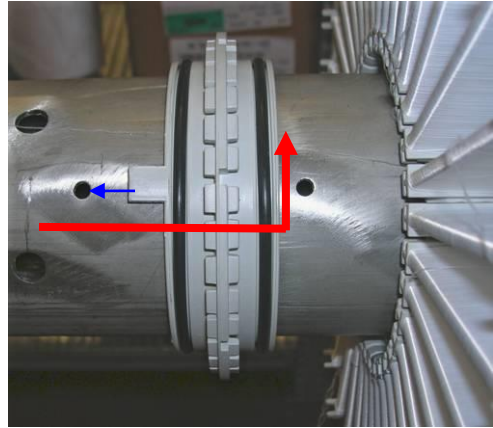
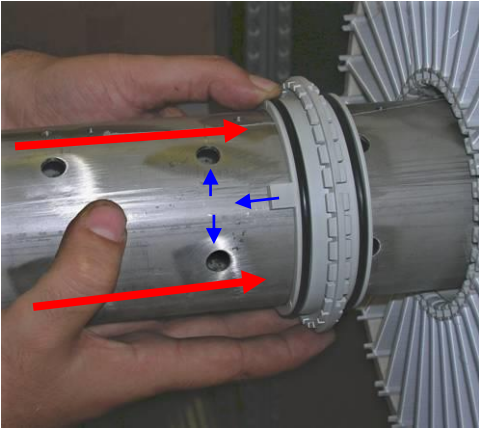

7. Remove the Cassette Holder Ring from the Cartridge.

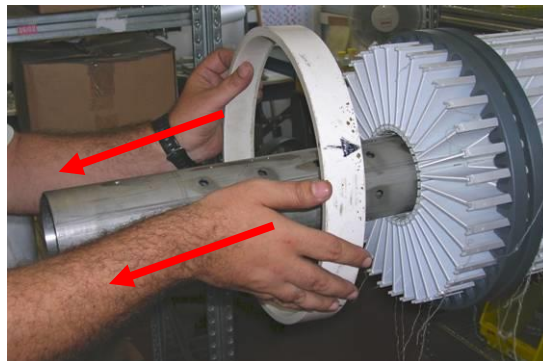

8. Repeat steps 2-7 till Cassettes Package number 24 and its Connector are installed.

9. Re-screw the 2 Machine Screws to their respective holes in the Central Pipe between Cassette Packages 24 and 25 (2-3).

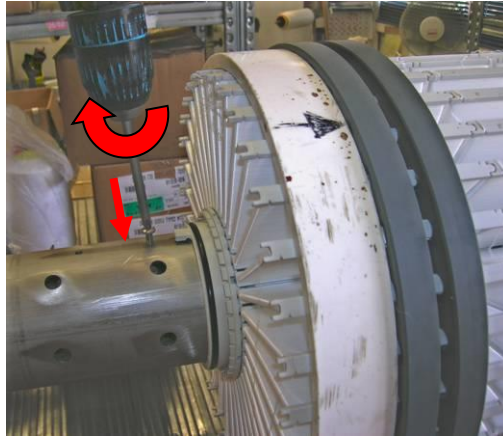

10. Install Cassettes Packages number 25 and 26. Please note that the last Cassettes Connector is different than the rest and it is actually Half Cassettes Connector.

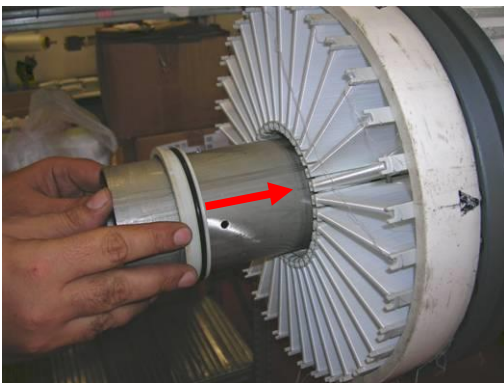

11. Insert the 2 O-ring seals over the Central Pipe and use a screwdriver to gently push the first O-ring to its place under the Half Cassettes Connector.

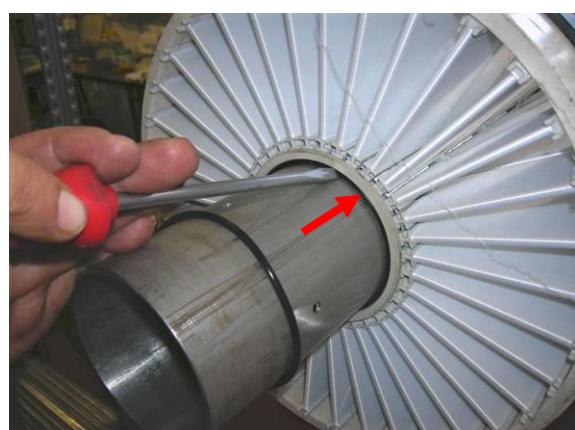
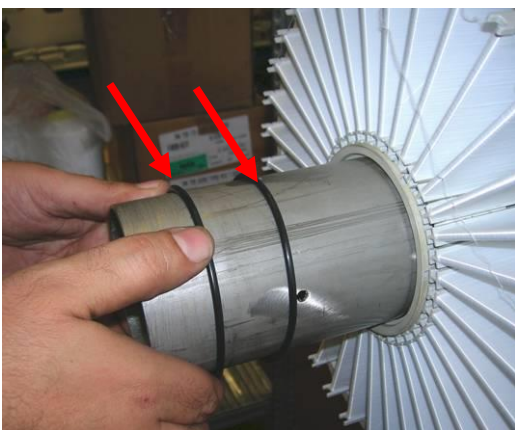

12. Push the Second O-ring to its place next to the first O-ring and the Half Cassettes Connector.

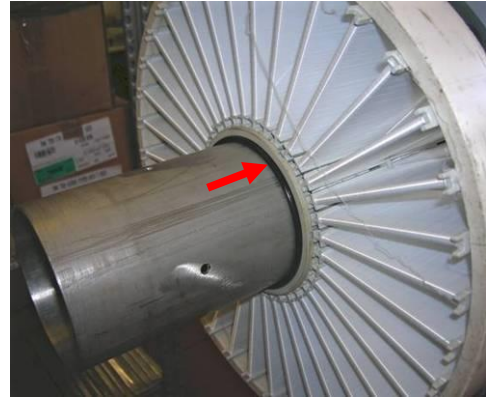

13. Remove the Cassette Alignment Ring and the Cassette Holder Ring from the cartridge.

14. Insert the Nozzle Guide cog-wheel over the Central Pipe and push it towards the first Cassette Pack. Turn the cog-wheel till its marking hole is aligned with the central line of the cartridge as indicated by the male U-shape of the Leading Cassette of the first Cassettes Pack.

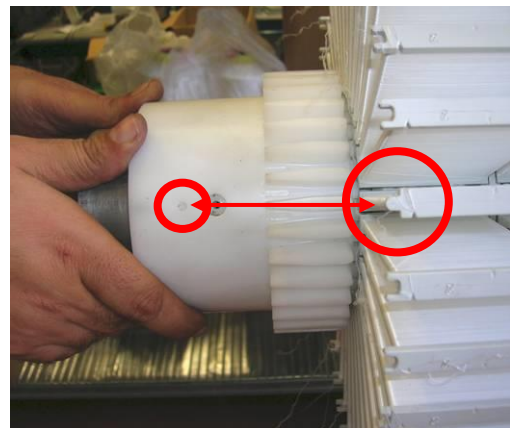
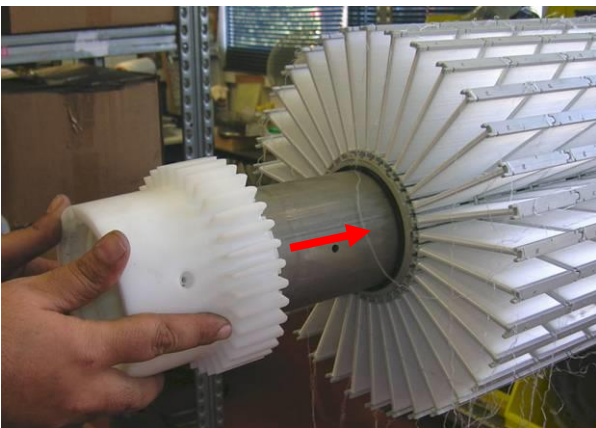

15. Insert the Guide Plate over the Central Pipe and use it to push the Nozzle Guide cog-wheel till it is firmly connected to the first Cassettes Package.

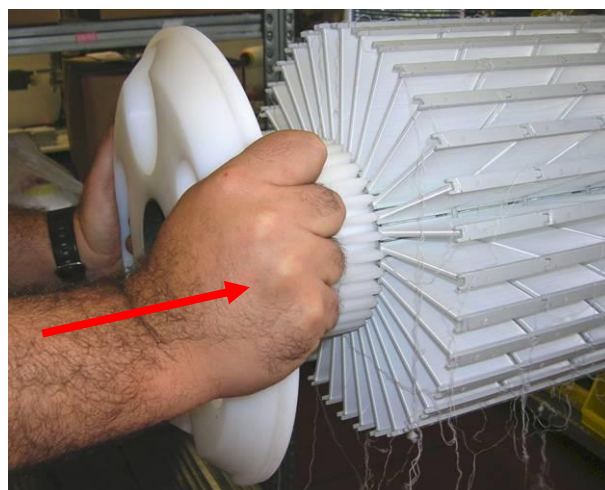

16. Align the Guide Plate and the Nozzle Guide cog-wheel marking holes with the Cartridge center line as indicated by the male U-shape of the Leading Cassette of the first Cassettes Pack. Insert the Shaft Bearing to the Central Pipe through the Guide Plate. Make sure that one of the holes in the Shaft Bearing is aligned with the cartridge center line.

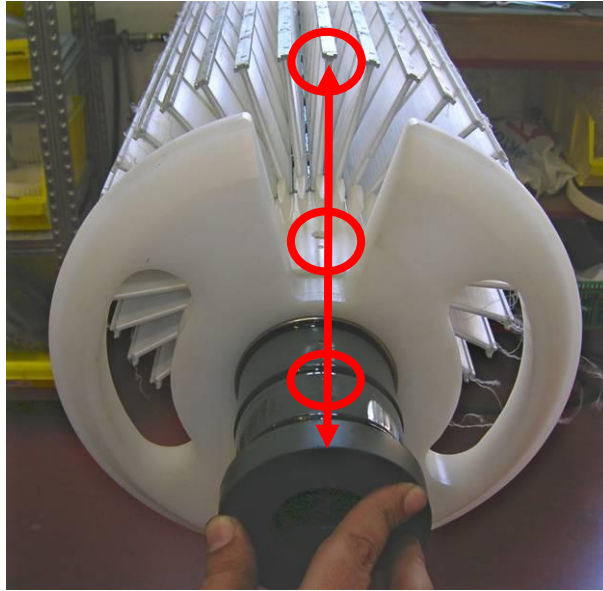

17. Use a hammer and soft-edge plastic or wooden stake to push the Shaft Bearing to its place next to the Guide Plate.



18. Re-screw the 4 Self Tapping Screws to the Nozzle Guide cog-wheel.

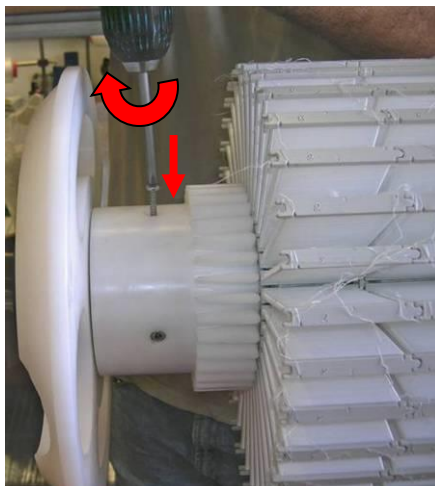

F. Reassembling the filter:

1. Lift the cartridge, turn its Guide Plate till the V-shape slot is pointing upwards and gently pass it through the opening of the chamber. Put the Guide Plate on the two supporting bars, located along the bottom of the chamber. Make sure that the O-ring seal is in its place on the Partition Plate and push the cartridge in to its full length. **Note: If the V-shape slot is not pointing upwards, it can be cached by one of the supporting bars causing damage to the cartridge.**

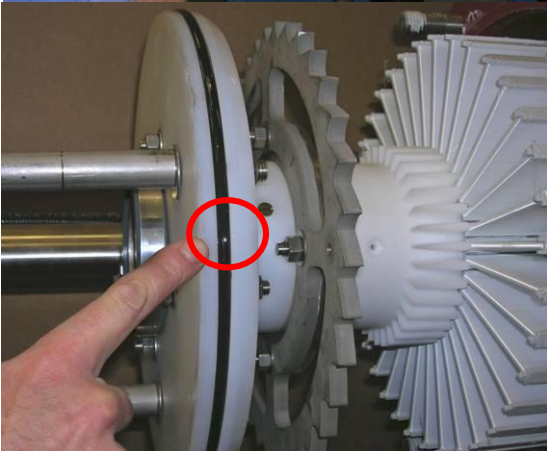
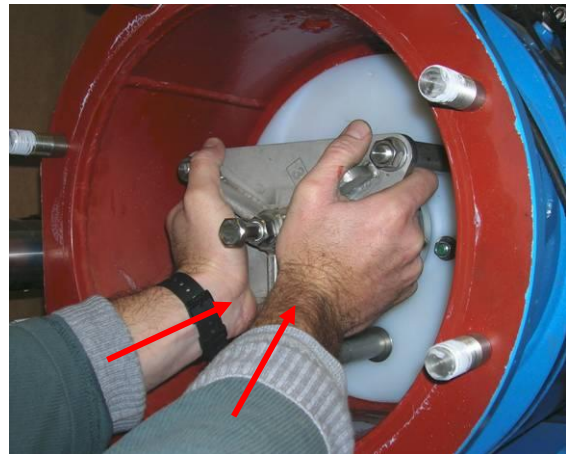
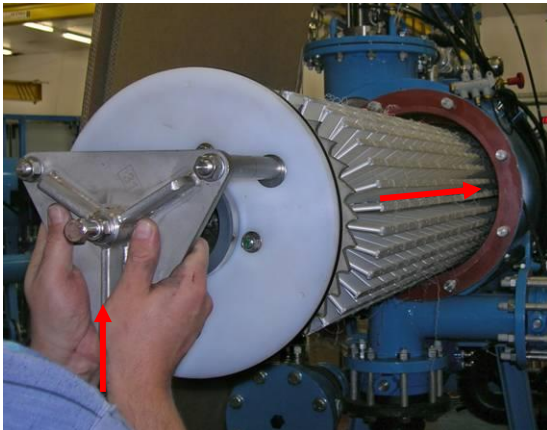

2. Make sure that the cartridge is fully inserted and its Partition Plate's O-ring seal is properly sits against the filter housing (1). Turn each one of three disc stoppers by 180° and make sure that they are extended beyond the borders of the Plate Partition (2). Re-screw and tighten the bolts of the stoppers (3).

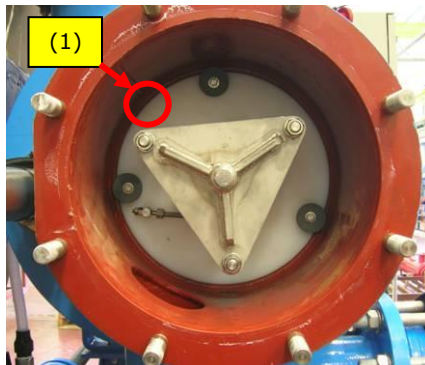

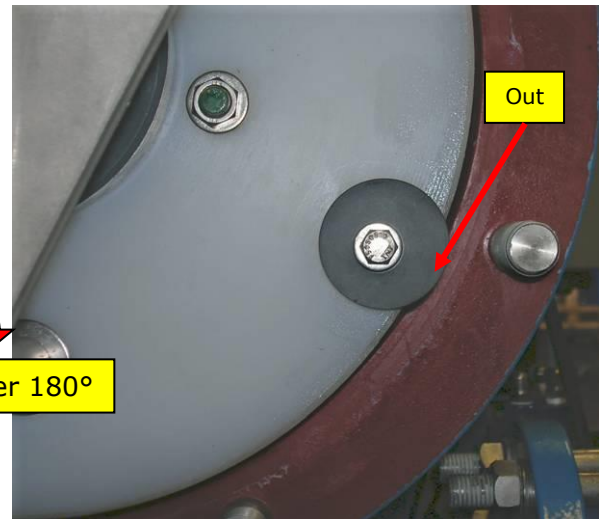
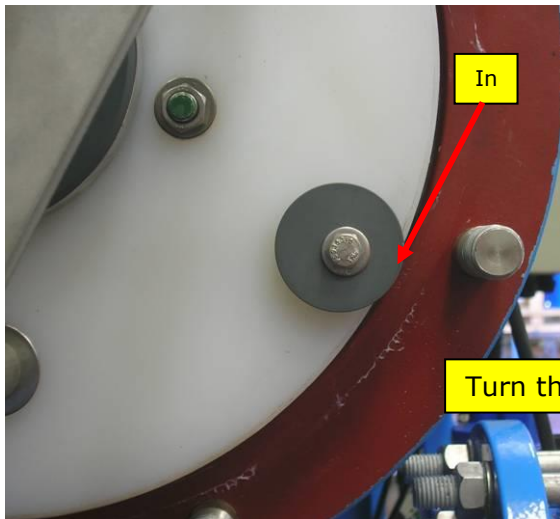
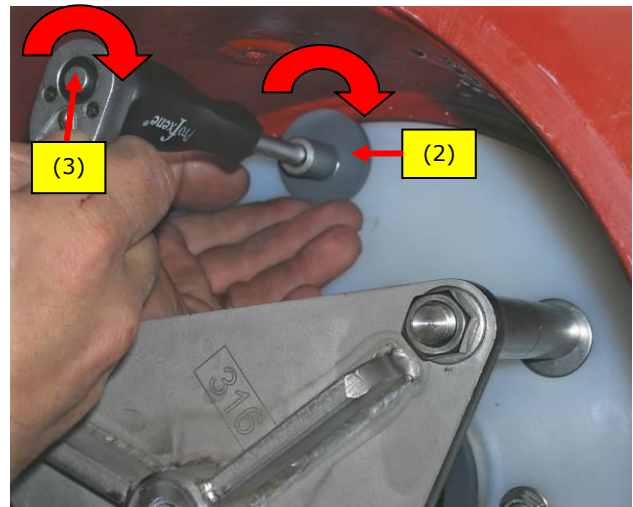
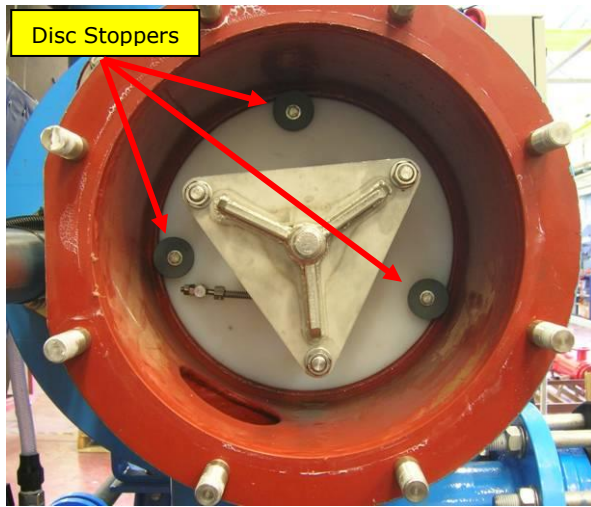

Turn the Stopper 180°

3. Make sure that the O-ring seal is properly located in its place on the cartridge lid.



4. Lift the lid back to its place and re-screw the bolts tightly.

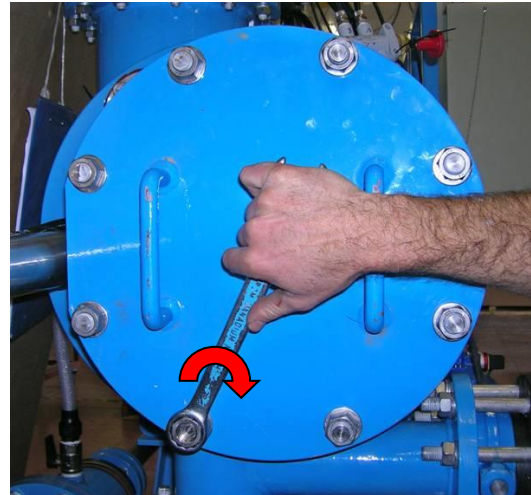
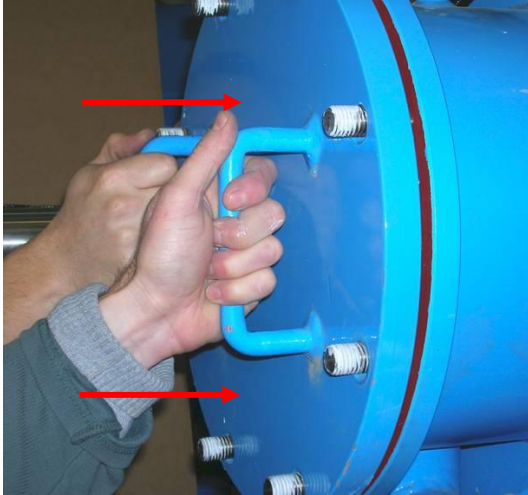

5. Go around the filter and locate the Guide Plate of the cartridge that was just inserted (1) and turn it till its V-shape slot points to the central line of the filter (2).

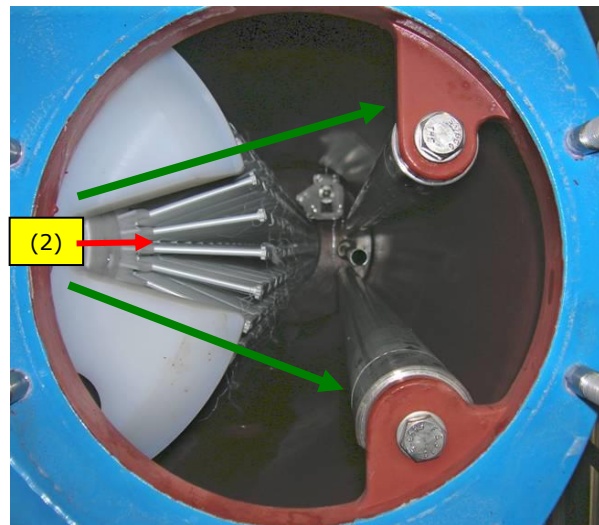
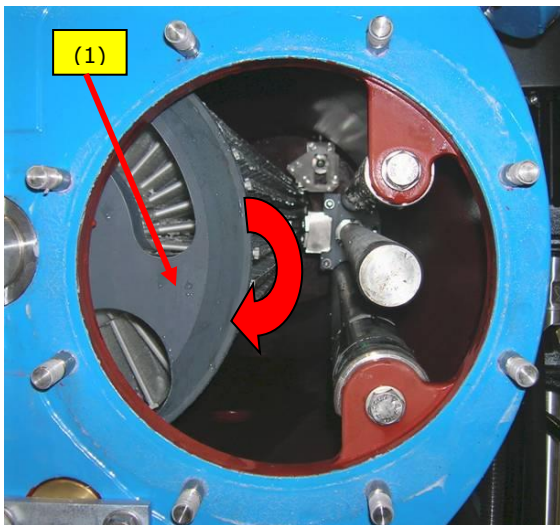

6. Insert Piston#40 into the filter body and make sure that that the following three points are met:
- i. The piston is inserted over the Tail Pipe Assembly located in the center line of the filter (1).
 - ii. The piston is inserted in the right direction (2).
 - iii. The spray nozzles are gently inserted in the gaps between the cassette rows (3) and are not hitting the cartridge while the piston is pushed in (you may need assistants to keep the piston balanced while pushing it into the filter).

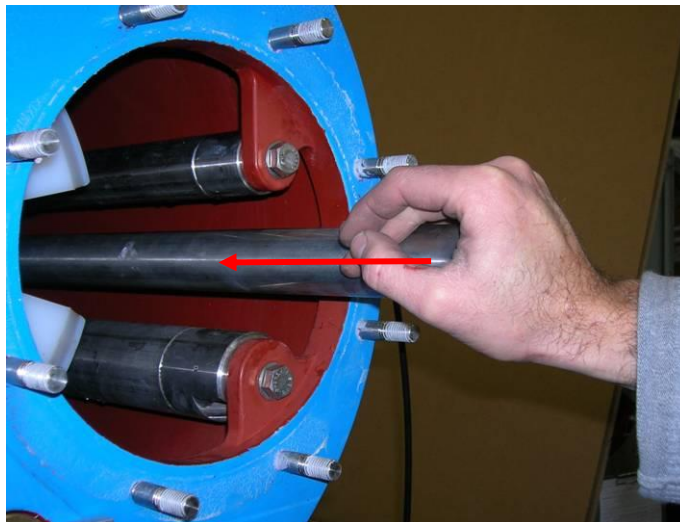
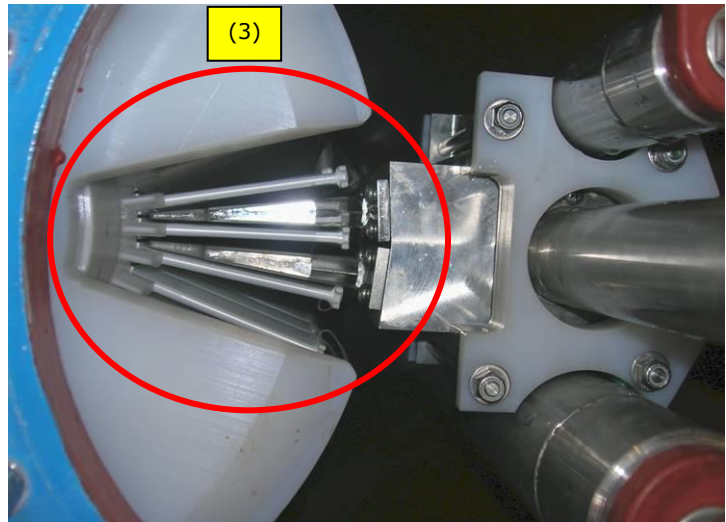
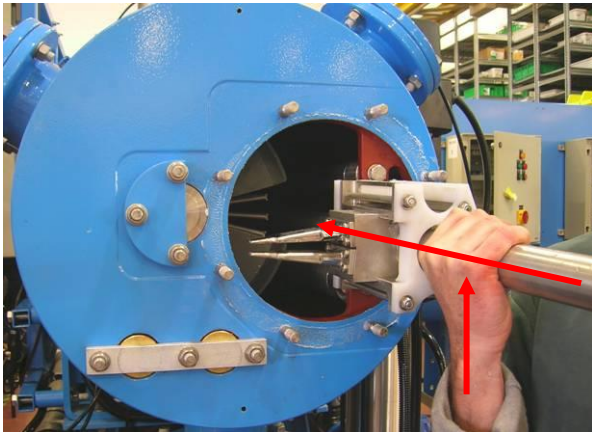
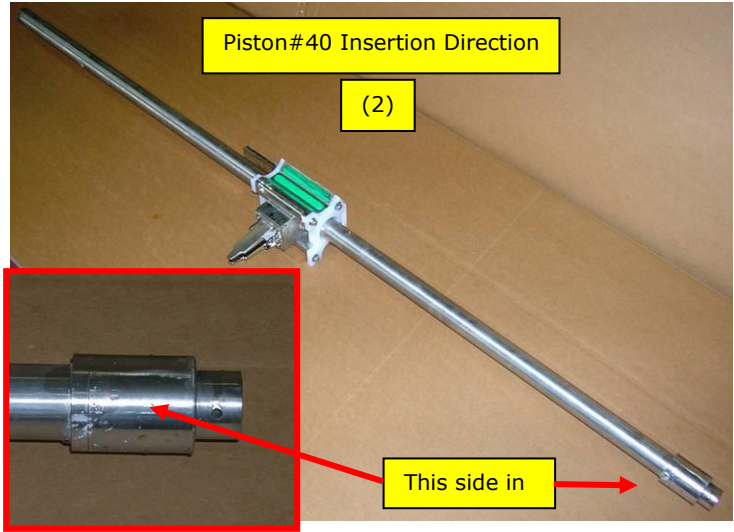
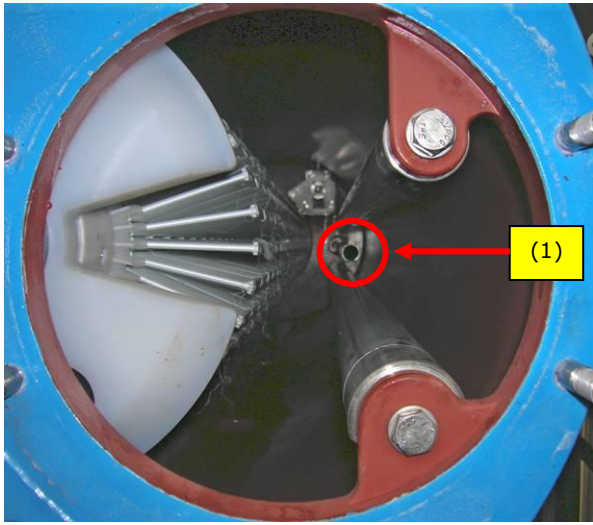

7. Gently Push Piston#40 into the filter till it slightly sticks out of the filter housing.

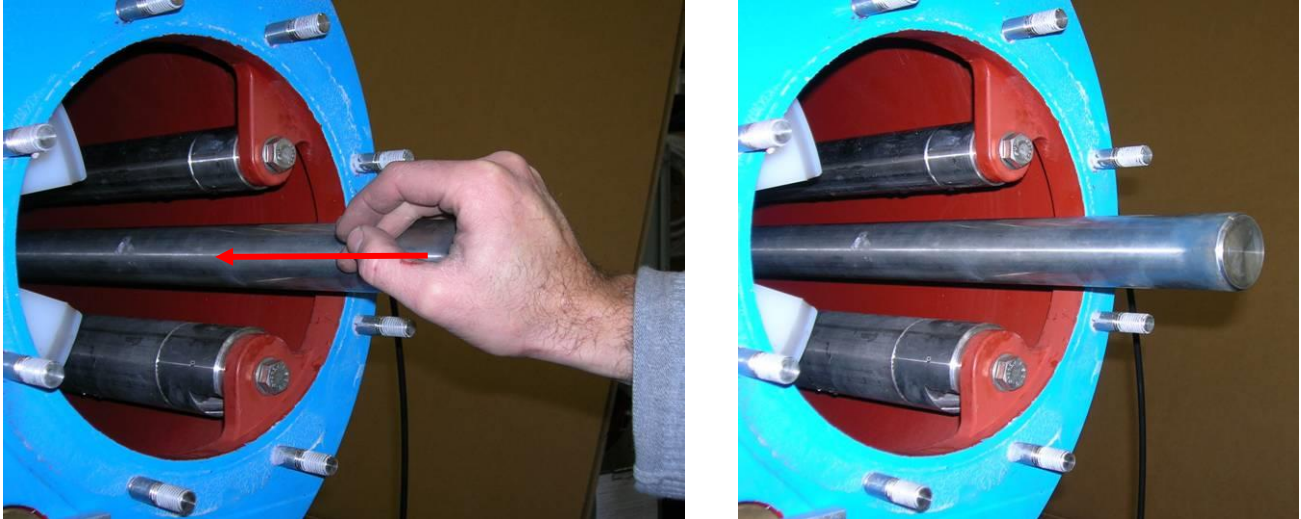

8. Insert the "Piston#50 (1), the Piston Housing (2) and the filter's Intermediate Cover (3) Assemblies" over Piston#40 and re-screw the Cover bolts. Make sure that these three components are aligned as shown in the following pictures and verify that the Cover's O-ring is in place (4).

Alignment Direction

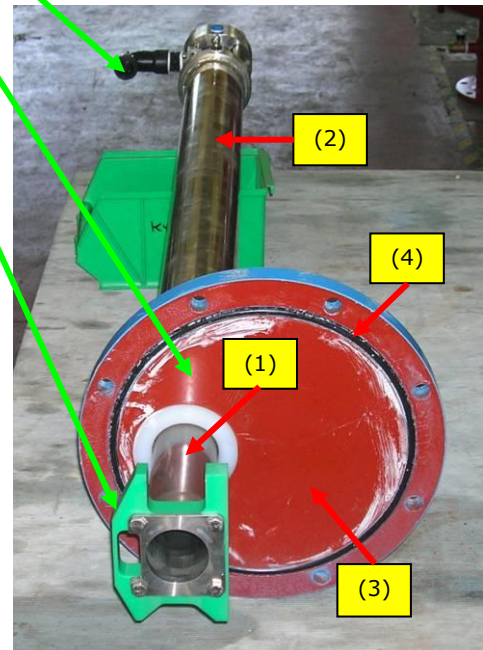
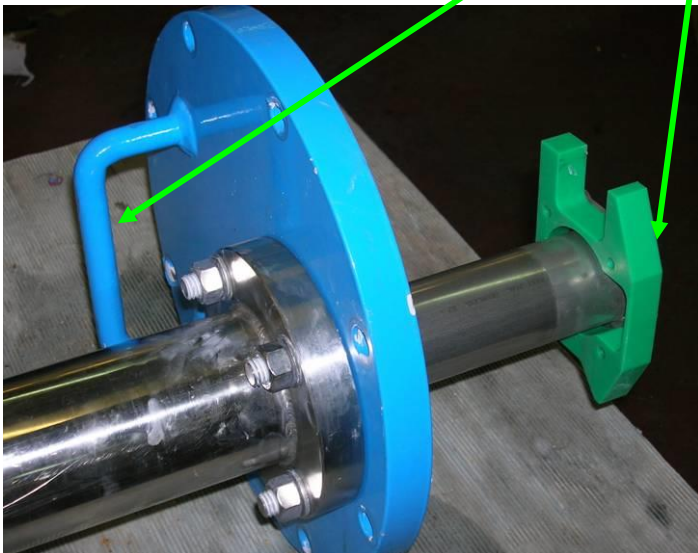

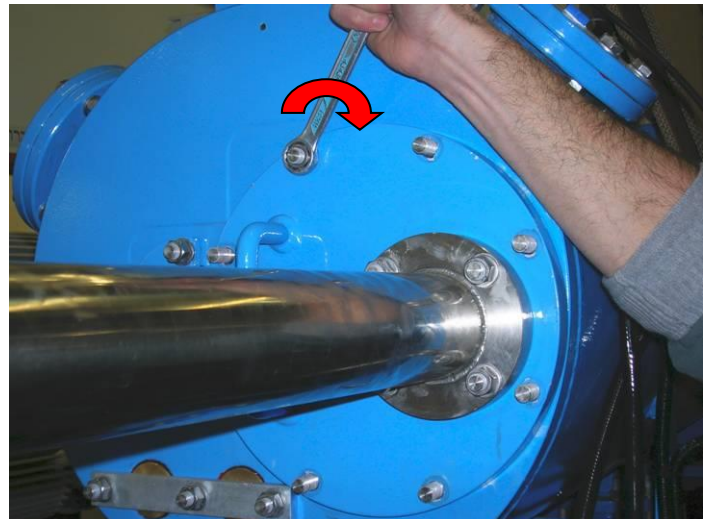
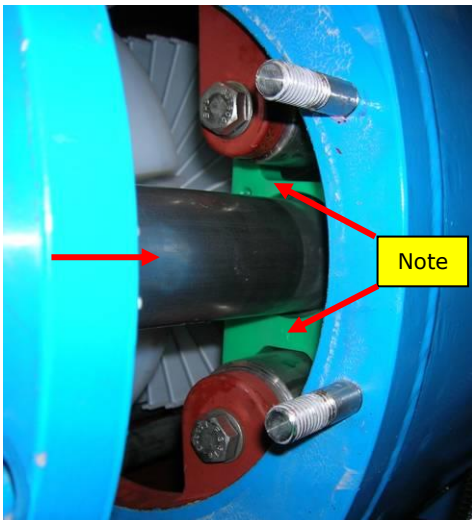
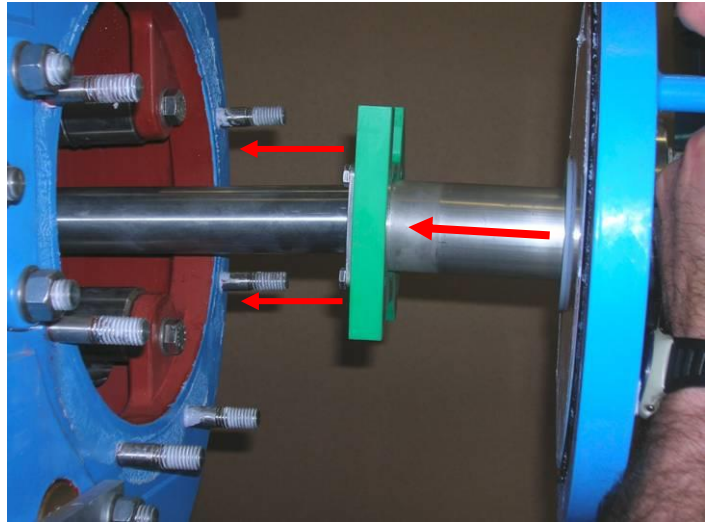
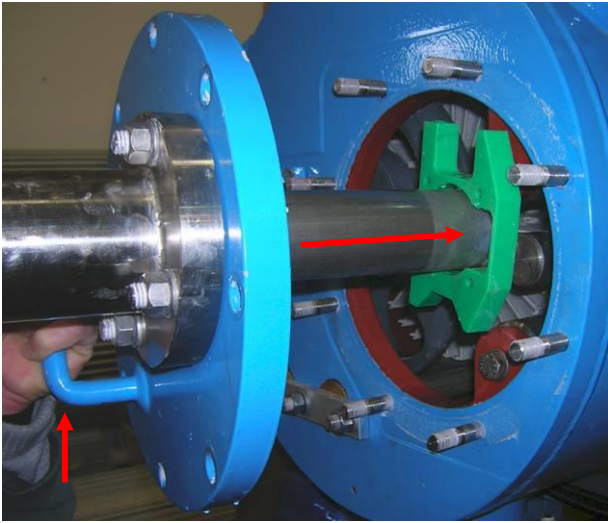

9. Connect the Proximity Switch SW1 to the Piston House Assembly by screwing the sensor to its Mounting block.

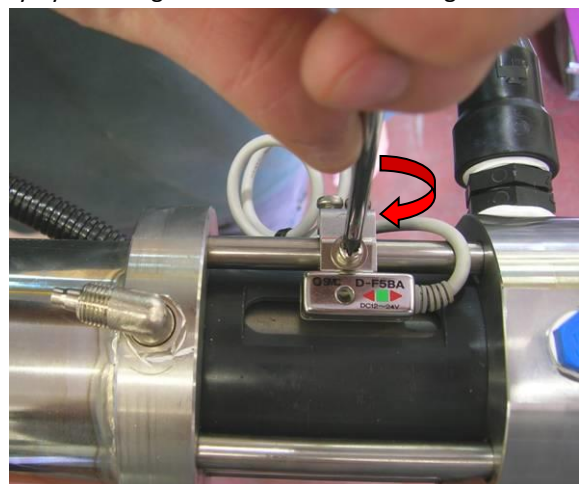
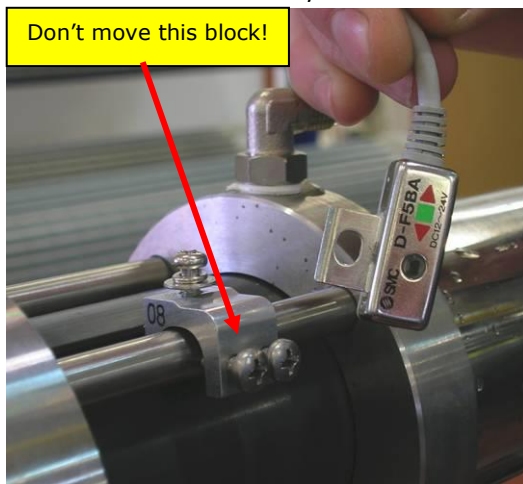

Note: Do not change the position of the mounting block! It was calibrated in the factory.

10. Connect the control tube to the Piston House Assembly.

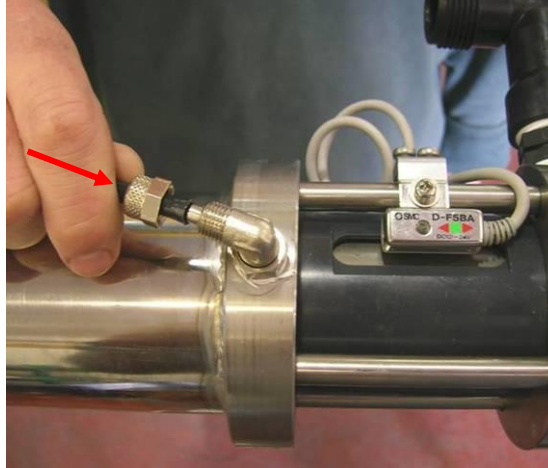

11. Connect the High Pressure pipe to the far end of the Piston House Assembly.

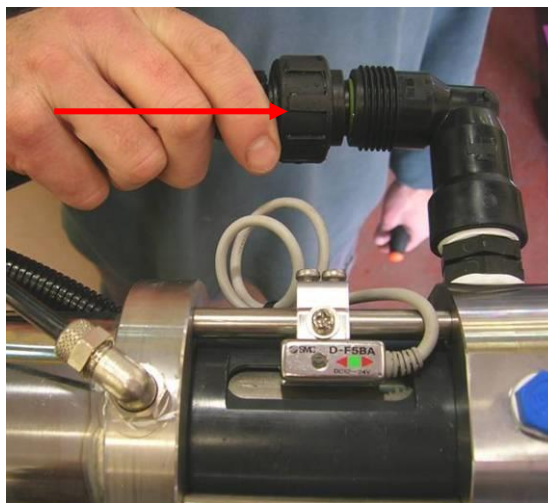

12. Re assembles the original control tubes of the upper Index Piston by removing the temporary compressed air connections and reconnecting the water control tubes.



G. Restarting the filter:

Perform a complete “Start-up and First Operation” procedure as described in chapter 4 of the user manual.

Important note: An attempt to restart the filter without performing a complete “Start-up and First Operation” procedure may result in serious malfunction of the filter

Bill of material

Material List

Description:	old Cat. #:	Catalog #:	quantity:	Grade of Raw Materials:
--------------	-------------	------------	-----------	-------------------------

1	Stop Plate Assy.	3470501	55-8040-0501	1	S/ST304
2	Bearing Partition Assy.	3473502		1	PTFE , PVC
3	Pipe Central Assy.	3470512	55-8040-0512	1	S/ST304
4	Hexagonal Bolt ½" UNC X 50	5631107	85-4111-08-050	1	S/ST316
5	Guide Nozzle	5470549	65-8040-0549	2	DELTRIN
6	Shaft Bearing	3470515	65-8040-0515	1	PVC
7	Cassettes Holder	5470559	65-8040-0559	26	PVC
8	Band Brake Assy.	3470508	55-8040-0508	1	S/ST304
9	Spring Brake Assy.	3470509	55-8040-0509	1	S/ST304
10	Connector Cassettes Half	5470547	65-8040-0547	2	NORYL
11	Ring Stop	5470511	65-8040-0511	1	PVC
12	Plate Guide	5470512	55-8040-0512	1	PVC
13	Gear Turn	5470518	65-8040-0518	1	S/ST304
14	Rod Tie	5470519	65-8040-0519	3	S/ST304
15	Spacer Pipe	5470520	65-8040-0520	3	S/ST304
16	Plate Partition	5470521	65-8040-0521	1	PVC
17	Special 3/8" Bolt	5470526	65-8040-0526	4	S/ST316
18	Connector Cassettes	5470544	65-8040-0544	25	NORYL
19	Disc Stop	5470531	65-8040-0531	3	PVC
20	Ring Stop	5470532	65-8040-0532	1	S/ST303
21	Pin Cotter 3.2 x 18 long	5740207	84-65-74-0207	1	S/ST316
24	Seal O-Ring	5610040	81-41-4001-0450	1	NIT. RUB
25	Seal O-Ring	5610112	81-41-4000-0337	2	NIT. RUB
26	Seal O-Ring #229	5610019	81-41-4000-0239	52	NIT. RUB
27	Seal U-Ring	5610532	81-41-4561-0532	1	NIT. RUB
28	Hexagonal Nut ¼" UNC	5620010	85-2211-04-000	2	S/ST316
29	Hexagonal Nut ½" UNC	5620012	85-4211-08-000	7	S/ST316
30	Hexagonal Nut 3/8" UNC	5620015	85-4211-06-000	12	S/ST316
31	Plain Washer 3/8"	5621012	85-4311-06-000	12	S/ST316
32	Plain Washer M12	5621019	85-4312-12-000	6	S/ST316
33	Plain Washer ¼"	5621029	85-4312-06-001	4	S/ST316
34	Machine Screw 10-24 UNC	5630206	81-4141-01-016	4	S/ST316
35	Self Tapping Screw AB10X1"	5630605	85-4125-10-025	11	S/ST316
36	Hexagonal Bolt ¼" UNC	5631103	85-4111-04-030	1	S/ST316
37	Stud bolt 3/8" x 70	5640117	85-4431-06-070	4	S/ST316
38	Machine Screw 10-24UNC X 3/8"	5630506	85-4151-01-009	4	S/ST316
42	Cassette Assy. type 1 2221111	3470022	55-8040-0022	468	NORYL
43	Cassette Assy. type 2 2221111	3470023	55-8040-0023	442	NORYL
44	Seal O-Ring	5610122	81-41-4000-0238	5	NIT. RUB

AMIAD LIMITED WARRANTY

This certificate applies to Amiad Products purchased by You from Amiad or an Amiad authorized Distributor (“Distributor”). This limited warranty extends only to the original purchaser, and is not transferable to anyone who subsequently purchases, leases, or otherwise obtains the Product from the original purchaser.

1. Amiad hereby warrants that the Products are and will be free from defects in material and workmanship under normal use and service. Amiad warrants that it will correct manufacturing defects in the Products, in accordance with the conditions set out in this warranty.
2. This warranty is enforceable for a period of 12 months after the date Bill of Lading or equivalent (the “Warranty Period”).
3. In the event that during the Warranty Period the Distributor discovers a defect in material and/or workmanship in any Product or part (the “Defective Product”), it shall submit a written complaint to Amiad using Amiad's standard customer complaint form. For the receipt of the customer complaint form, the submission of the complaint or any questions please contact your customer service representative.
4. Upon written demand by Amiad the Distributor shall return the Defective Products – or a sample thereof – to Amiad, at Amiad's cost. If the customer ships any such Product, Amiad suggests the customer package it securely and insure it for value, as Amiad assumes no liability for any loss or damage occurring during shipment. Provided however that in the event Amiad determines that the warranty does not apply to such Product, Distributor shall promptly reimburse Amiad for such cost (including freight and customs). Any returned Product or part must be accompanied by the warranty certificate and the purchase invoice. It is clarified that the Distributor may not return the Defective Product unless such return was coordinate and approved by Amiad in advance.
5. Amiad's obligation under this warranty shall be limited to, at its option, the repair or exchange, free of charge, of the Product or any part which may prove defective under normal use and service during the Warranty Period. The provision of a repaired or replacement Product during the Warranty Period will result in an extension of the Warranty Period by an additional period of 12 months, provided that the total accumulated Warranty Period shall in any event be no more than 18 months from the original Bill of Lading.
6. This warranty is valid on the condition that the Products are installed according to Amiad's instructions as expressed in Amiad's instruction manuals and according to the technical limitations as stipulated in Amiad's literature or as stated by a representative of Amiad.
7. This warranty will not apply to damaged or defective Products resulting from or related to:
 - (i) Fire, flood, power surges or failures or any other catastrophe/and or unforeseen occurrence, such as but not limited to those for which the customers are customarily insured;
 - (ii) Fault, abuse or negligence of the customer;
 - (iii) Customer's responsibilities, including the failure of the intake water to meet the agreed standards, as set forth in a written document, approved by Amiad or improper storage.
 - (iv) Improper or unauthorized use of the Product or related parts by the customer, including the customer's failure to operate the Product in conformity with the recommendations and instructions of Amiad, as set forth in Amiad's manuals and other written materials, the operation of the Product other than by a trained and qualified operator, or improper installation of the Product by a third party not authorized by Amiad;
 - (v) Performance by the customer of maintenance and other services other than by a trained and qualified advanced operator, or other than in conformity with the recommendations and instructions of Amiad, or other than in accordance with procedures defined in the literature supplied for Products;
 - (vi) Any alteration, modification foreign attachment to or repair of the Products, other than by Amiad or its authorized technical representatives.
8. In no event shall Amiad be liable to the customer or any third party for any damages, including indirect, special, exemplary, punitive or consequential damages, or lost profits arising out of or in connection with this warranty, or arising out of or in connection with the Product's performance or failure to perform, even if it has been advised of the possibility of such damages.
9. Amiad will be excused for failure to perform or for delay in performance hereunder if such failure or delay is due to causes beyond its reasonable control or force majeure preventing or hindering performance.
10. The limited warranty set forth herein is the only warranty given by Amiad and is provided in lieu of any other warranties created by any documentation, packaging or otherwise.
11. Amiad makes no warranty whatsoever in respect of accessories or parts not supplied by Amiad. In the event that Amiad is required to correct a defective Product or product not covered by this warranty, it will do so solely in consideration for additional fees.

Алматы (7273)495-231
Ангарск (3955)60-70-56
Архангельск (8182)63-90-72
Астрахань (8512)99-46-04
Барнаул (3852)73-04-60
Белгород (4722)40-23-64
Благовещенск (4162)22-76-07
Брянск (4832)59-03-52
Владивосток (423)249-28-31
Владикавказ (8672)28-90-48
Владимир (4922)49-43-18
Волгоград (844)278-03-48
Вологда (8172)26-41-59
Воронеж (473)204-51-73
Екатеринбург (343)384-55-89

Иваново (4932)77-34-06
Ижевск (3412)26-03-58
Иркутск (395)279-98-46
Казань (843)206-01-48
Калининград (4012)72-03-81
Калуга (4842)92-23-67
Кемерово (3842)65-04-62
Киров (8332)68-02-04
Коломна (4966)23-41-49
Кострома (4942)77-07-48
Краснодар (861)203-40-90
Красноярск (391)204-63-61
Курск (4712)77-13-04
Курган (3522)50-90-47
Липецк (4742)52-20-81

Магнитогорск (3519)55-03-13
Москва (495)268-04-70
Мурманск (8152)59-64-93
Набережные Челны (8552)20-53-41
Нижегород (831)429-08-12
Новокузнецк (3843)20-46-81
Новосибирск (3496)41-32-12
Новосибирск (383)227-86-73
Омск (3812)21-46-40
Орел (4862)44-53-42
Оренбург (3532)37-68-04
Пенза (8412)22-31-16
Петрозаводск (8142)55-98-37
Псков (8112)59-10-37
Пермь (342)205-81-47

Ростов-на-Дону (863)308-18-15
Рязань (4912)46-61-64
Самара (846)206-03-16
Санкт-Петербург (812)309-46-40
Саратов (845)249-38-78
Севастополь (8692)22-31-93
Саранск (8342)22-96-24
Симферополь (3652)67-13-56
Смоленск (4812)29-41-54
Сочи (862)225-72-31
Ставрополь (8652)20-65-13
Сургут (3462)77-98-35
Сыктывкар (8212)25-95-17
Тамбов (4752)50-40-97
Тверь (4822)63-31-35

Тольятти (8482)63-91-07
Томск (3822)98-41-53
Тула (4872)33-79-87
Тюмень (3452)66-21-18
Ульяновск (8422)24-23-58
Улан-Удэ (3012)59-97-51
Уфа (347)229-48-12
Хабаровск (4212)92-98-04
Чебоксары (8352)28-53-07
Челябинск (351)202-03-61
Череповец (8202)49-02-64
Чита (3022)38-34-83
Якутск (4112)23-90-97
Ярославль (4852)69-52-93

Россия +7(495)268-04-70

Казахстан +7(7172)727-132

Киргизия +996(312)96-26-47

<https://amiad.nt-rt.ru> || afv@nt-rt.ru