

Алматы (7273)495-231
Ангарск (3955)60-70-56
Архангельск (8182)63-90-72
Астрахань (8512)99-46-04
Барнаул (3852)73-04-60
Белгород (4722)40-23-64
Благовещенск (4162)22-76-07
Брянск (4832)59-03-52
Владивосток (423)249-28-31
Владикавказ (8672)28-90-48
Владимир (4922)49-43-18
Волгоград (844)278-03-48
Вологда (8172)26-41-59
Воронеж (473)204-51-73
Екатеринбург (343)384-55-89

Иваново (4932)77-34-06
Ижевск (3412)26-03-58
Иркутск (395)279-98-46
Казань (843)206-01-48
Калининград (4012)72-03-81
Калуга (4842)92-23-67
Кемерово (3842)65-04-62
Киров (8332)68-02-04
Коломна (4966)23-41-49
Кострома (4942)77-07-48
Краснодар (861)203-40-90
Красноярск (391)204-63-61
Курск (4712)77-13-04
Курган (3522)50-90-47
Липецк (4742)52-20-81

Магнитогорск (3519)55-03-13
Москва (495)268-04-70
Мурманск (8152)59-64-93
Набережные Челны (8552)20-53-41
Нижний Новгород (831)429-08-12
Новокузнецк (3843)20-46-81
Ноябрьск (3496)41-32-12
Новосибирск (383)227-86-73
Омск (3812)21-46-40
Орел (4862)44-53-42
Оренбург (3532)37-68-04
Пенза (8412)22-31-16
Петрозаводск (8142)55-98-37
Псков (8112)59-10-37
Пермь (342)205-81-47

Ростов-на-Дону (863)308-18-15
Рязань (4912)46-61-64
Самара (846)206-03-16
Санкт-Петербург (812)309-46-40
Саратов (845)249-38-78
Севастополь (8692)22-31-93
Саранск (8342)22-96-24
Симферополь (3652)67-13-56
Смоленск (4812)29-41-54
Сочи (862)225-72-31
Ставрополь (8652)20-65-13
Сургут (3462)77-98-35
Сыктывкар (8212)25-95-17
Тамбов (4752)50-40-97
Тверь (4822)63-31-35

Тольятти (8482)63-91-07
Томск (3822)98-41-53
Тула (4872)33-79-87
Тюмень (3452)66-21-18
Ульяновск (8422)24-23-59
Улан-Удэ (3012)59-97-51
Уфа (347)229-48-12
Хабаровск (4212)92-98-04
Чебоксары (8352)28-53-07
Челябинск (351)202-03-61
Череповец (8202)49-02-64
Чита (3022)38-34-83
Якутск (4112)23-90-97
Ярославль (4852)69-52-93

Россия +7(495)268-04-70

Казахстан +7(7172)727-132

Киргизия +996(312)96-26-47

<https://amiad.nt-rt.ru> || afv@nt-rt.ru

Amiad Water Systems Ltd.

AMF-370K - S User Guide

Serial number: _____

Order number: _____

Catalog number: _____

Filtration degree: _____

Tested by: _____

Installation and Operation Instructions

Amiad Water Systems Ltd. AMF-370K -S User Manual

This manual is the operation manual of Amiad's AMF 370K-S filter; it describes the installation and the commissioning processes for a single filter installation and specifies the end-user operation procedures. For broadening the end-user's knowledge a general description of Amiad's micro-fiber filtration technology is also provided.



TABLE OF CONTENTS

1. Introduction & How to use this manual	4
1.1. Using this manual	4
1.2. Safety instructions.....	4
1.3. General description of the micro-fiber filtration technology	7
2. Installation	12
2.1. Pre-installation requirements	12
2.2. The Installation Process.....	14
3. Description of the control panel.....	29
3.1. Introduction.....	29
3.2. Components mounted on the control panels doors.....	29
3.3. Internal components of the control panels	29
3.4. Basic operation of the PLC	31
3.5. HMI operation principles.....	34
3.6. Finding your way within the system	37
3.7. Changing the HMI language	38
3.8. HMI screens description.....	39
3.9. List of system messages	55
4. Start-up and First Operation.....	57
4.1. Dry stage – connections verification	57
4.2. Wet stage A. – Initial flushing cycle.....	62
4.3. Wet stage B. – First filtration cycle.....	65
5. Technical Specifications	66
5.1. Standard AMF 370K-S Specifications	66
5.2. Control cabinet drawings	68
6. Maintenance Instructions.....	83
6.1. Daily and weekly maintenance.....	83
6.2. Annual maintenance	83
6.3. Parts schedule and drawings.....	84
7. AMIAD LIMITED WARRANTY.....	85

1. Introduction & How to use this manual

1.1. Using this manual

This manual describes the end-user operation procedures of Amiad's AMF 370K-S filter. For broadening the user's general knowledge a general description of Amiad's micro-fiber filtration technology and some basic information on installation is also provided.

This manual does not replace the Technicians' Installation, Service and Maintenance Manuals and it should not be used for any task other than the regular operation of the filter.

Before operating the filter please read this manual carefully. Make sure that:

- You are familiar with the safety instructions (Chapter 1.2)
- You understand the basics of the Micro-fiber filtration technology (Chapter 1.3)
- You know how to use the control panel (Chapter 3)

1.2. Safety instructions

1.2.1 General

- Amiad filtration products always operate as components in a larger system. It is essential for the system designers, installers and operators to comply with all the relevant safety standards.
- Prior to installation, operation, maintenance or any other type of action carried out on the filter, read carefully the safety, installation and operation instructions.
- During installation, operation or maintenance of the filter all conventional safety instructions should be observed in order to avoid danger to the workers, the public or to property in the vicinity.
- Please note: The filter enters into a flushing mode automatically, without prior warning.
- No change or modification to the equipment is permitted without a written notification given in advance by the manufacturer or by its representative, on the manufacturer's behalf.
- Always observe standard safety instructions and good engineering practices whilst working in the filter's vicinity.
- Use the filter only for its intended use as designed by Amiad, any misuse of the filter may lead to undesired damage and may affect your warranty coverage. Please consult with Amiad prior to any non-regular use of this equipment.

1.2.2 Installation

General

- Install the filter according to the detailed Installation Instructions provided with the filter by the manufacturer and according to the description given in this manual.
- Make sure to leave enough clearance so as to enable easy access for future treatments and safe maintenance operations.
- The user should arrange suitable lighting at the area of the filter to enable good visibility and safe maintenance.
- The user should arrange suitable platforms, ladders and safety barriers to enable easy and safe access to the filter without climbing on pipes and other equipment. The user should verify that any platform, barrier, ladder or other such equipment is built, installed and used in accordance with the relevant local authorized standards.
- Check and re-tighten all bolts during commissioning and after the first week of operation.
- Use only appropriate standard tools and equipment operated by qualified operators when installing, operating and maintaining the filter.
- When installation is required in hazardous environment sites, underground or high above ground, make sure that the site design and the auxiliary equipment are appropriate and that installation procedures are carried out in accordance with the relevant standards and regulations.
- Ensure walking areas about the installation are slip free when wet.

Shipment and transporting

- Shipping and transporting the filter must be done in a safe and stable manner and in accordance with the relevant standards and regulations.
- For shipping, lifting and positioning the filter, use only approved lifting equipment and authorized employees and contractors.

Electricity

- Electric wiring should be performed by an authorized electrician only, using standardized and approved components.
- Install a lockable main power cut-off switch close to the control panel.
- If due to site constraints, the control panel is installed without a clear line-of sight of the filter, an additional lockable power disconnect cut-off switch should be installed near each filter unit.
- Installation of the filter should be performed so as to avoid direct water splashing on the electrical components or on the control panel.

Pneumatics

- Install a **lockable** main cut-off switch, **featured with a pressure release mechanism**, on the compressed air supply line close to the control panel.
- If the control panel is installed far away and there is no eye contact with the filter, a **lockable** compressed air cut-off switch, **featured with a pressure release mechanism**, should be installed near each filter unit.
- The user should make sure that the compressed air supplied to the filter never exceeds the maximum designated pressure for this filter. An air-pressure reduction valve should be installed on the compressed air supply line upstream of the filter's pneumatic inlet port.

Hydraulics

- Extra safety devices should be installed on hot water applications to avoid skin burn danger.
- The user should install a manual Water Cut-off Valve next to the filter's inlet port.
- In cases where the downstream piping network downstream of the filter is pressurized an additional manual Water Cut-off Valve should be installed next to the filter outlet port.
- The user should make sure that the system includes a Pressure Release / Drainage Valve to enable release of residual pressure prior to any maintenance procedure performed on the filter.
- The user should make sure that the filter is never exposed to water pressure exceeding the maximum designated pressure for this filter, if needed a Pressure Reduction Valve should be installed upstream of the filter's water inlet port.
- Please note that the maximum working pressure indicated at the filter's specifications table includes the pressure caused by fluid hammer and pressure surge effects.

Civil Engineering

- Make sure that the filter installation is done by Amiad qualified technicians.
- Make sure that any civil engineering work at the installation site such as construction, lifting, welding, etc. is done by qualified workers / technicians / contractors and in accordance with the relevant local standards.
- While using lifting equipment, make sure that the filter or the lifted part is chained securely and in a safe manner.
- Do not leave lifted equipment if there is no necessity. Avoid working below lifted equipment.
- Wear a safety helmet while using lifting equipment.
- Make sure that the flooring is sloped for drainage and to avoid accumulation of liquids.

1.2.3 Operation, Control and Maintenance

Commissioning

- Read carefully the Commissioning and the First Start-up Operation instructions prior to any attempt to operate the filter.
- In order to achieve maximum performance and smooth operation of the filter it is crucial to perform the Startup and First Operation procedures exactly as described in this manual.
- Commissioning the filter should be done by an authorized Amiad technician, do not attempt to commission the filter unaccompanied since this may lead to undesired damage and may affect your warranty coverage.

Operation and Control

- Do not operate the filter before reading carefully and being familiar with its operation instructions.
- Observe the safety stickers on the filter and never perform any operation contradicting the instructions given.
- Never operate or use the filter for purposes other than its original design and operational envelope.

1.2.4 Maintenance

Before any maintenance or non-regular operation please read the following:

- Servicing the filter should be done only by technicians authorized by Amiad.
- Disconnect the filter from the power supply and lock the Main Power Switch.
- Disconnect the compressed air supply, release the residual pressure and lock the Pneumatics Main Valve.
- Disconnect the filter from the water system by closing and securing the Manual Inlet Valve. In cases where the downstream piping network is pressurized, close and secure the Manual Outlet Valve also.
- Release the residual water pressure by opening the Pressure Release / Drainage Valve.
- Empty the filter by opening the Drainage Valve.
- In hot water systems wait till the filter components cool off to a safe temperature.
- Place warning signs around the work area as required by the local standards and procedures.
- Inspect the filter's safety stickers and replace any damaged or faded sticker.

Mechanical

- When working on the filter use only appropriate standard tools.
- Always open and close valves slowly and gradually.
- Remove grease and fat material residues in order to avoid slipping.
- Before disconnecting the filter from the water supply, electricity and pneumatics and before releasing the filter's residual pressure do NOT:
 - loosen or unscrew bolts
 - remove any protection cover
 - open any service port flange
- Avoid splashing and water leakage so as to minimize slippage, electrification or damage to the equipment, caused by moisture.
- While using lifting equipment, make sure that the filter or the lifted part is chained securely and in a safe manner.
- Do not leave lifted equipment if there is no necessity. Avoid working below lifted equipment.
- Wear a safety helmet, goggles, gloves, and any other personal safety equipment required by the local standards and regulations.
- Human entry into a filter must be done in accordance with the relevant local safety instructions, standards and regulations for working in hazardous environment.
- Manual cleaning of filter media using high water pressure or steam should be performed in accordance with the cleaning system instructions, the local standards and regulations and without endangering the operator or the vicinity
- Manual cleaning of filter element using acid or other chemical agents should be performed in accordance with the relevant material safety instructions, the local standards and regulations and without endangering the operator or his vicinity.

1.2.5 Before returning to regular operation

- Re-assemble any protection covers or protection mechanisms removed during service or maintenance operations.
- Make sure that all the tools, ladders, lifting devices, etc. used during the maintenance procedures are taken away from the filter area and stored
- In order to return the filter to regular operation, follow the First Start-up Operation instructions as detailed in your user manual.
- For filters used in potable water systems it is required to disinfect the filter according to the local water authority standards and regulations before putting it back to service.

1.3. General description of the micro-fiber filtration technology

Textile fibers are widely used for fine filtration in the disposable cartridge filter market. Amiad Filtration Systems developed an innovative self-cleaning micro-fiber filtration technology and implemented it on a wide range of automatic filters. For the end-user general knowledge the following paragraph describes the basics of this technology.

Please note:

Each model of Amiad's micro-fiber filters has a different size, flow-rate and number of cartridges, therefore the drawings and pictures used in this description do not necessarily reflect the actual layout and components of your actual filter, they are provided for explaining the technology only.

1.3.1 Filter Media

Amiad AMF filter is based on Amiad's automated micro-fiber technology. The basic component of this filtration technology is the Cassette which is a filter media consists of a grooved rigid plastic plate over which multi layer textile threads have been wound (Fig1). The thread type and tension together with the number of layers define the filtration degree from ten down to two microns.

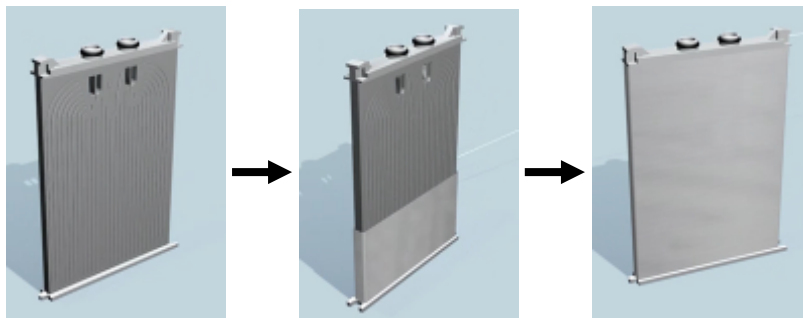

Figure 1

35 cassettes connected to a joined-in collector pipe unit form a package. 26 packages attached to each other form a cartridge (Fig2) which is installed in the filter housing (Fig3).

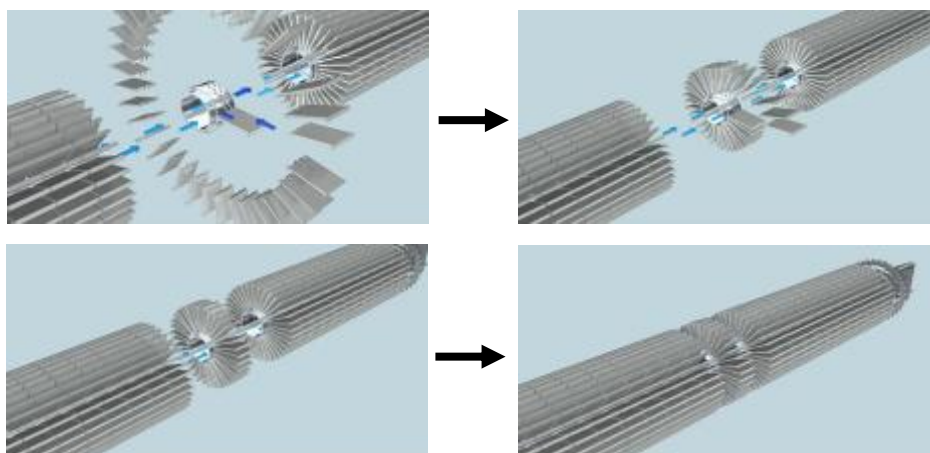

Figure 2

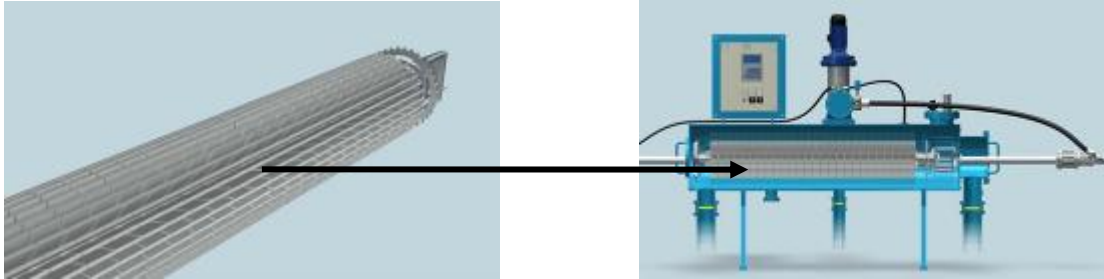

Figure 3

1.3.2 Filtration Process

The contaminated liquid flows from the inlet control valve, through the threads, into the grooves and through the nipples to the collector pipe, flowing to the clean liquid chamber and, through the outlet control valve, to the customer's system (Fig4+5).

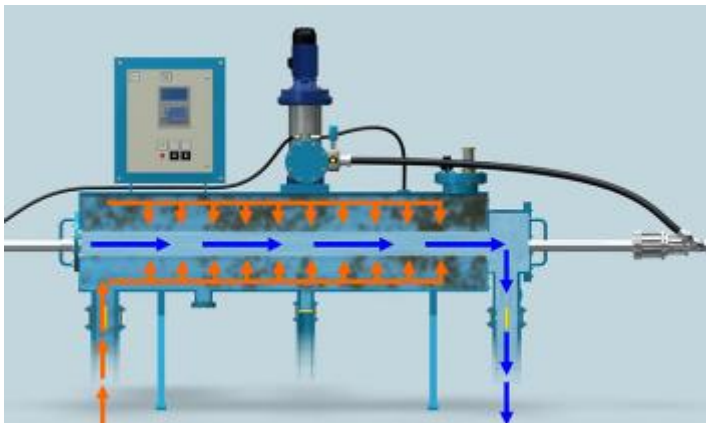
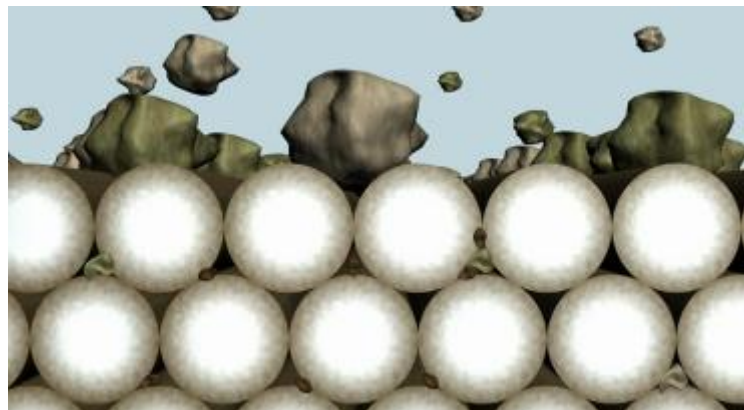

Figure 4



Figure 5

Larger dirt particles are stopped on the surface of the multiple layers of thread (Fig6) and form a filter cake. Finer particles that penetrate the surface are trapped deep inside the thread layers (Fig7). As dirt is stopped the filter differential pressure gradually increases.



1.3.3 The cleaning sequence

The control system activates the self cleaning sequence at a preset pressure differential level or by a preset timer, whichever comes first (Fig8).

The cleaning sequence starts with the control unit starting the flushing pump (Fig9), which boosts into the system highly pressurized clean water. The inlet and outlet valves are then closed isolating the filter from the main line. A few seconds later, the drain valve opens, emptying the filter (Fig10).



Figure 8



Figure 9



Figure 10

The highly pressurized water enters the filter through the flushing control valve, into a shuttle pipe fitted with a movable spray unit (Fig11). The spray unit (Fig12) moves back & forth along the entire length of one cartridge row, pushed by a piston driven in both directions by boosted water (Fig13).



Figure 11



Figure 12



Figure 13

Each spray nozzle creates multiple jet streams; these jets pass through the thread layers of the cassette, hit the plastic wall and are forced backwards. This creates a powerful spot back flush, which carries with it the trapped particles and the filter cake out of the cassettes thread layers and through the open drain control valve to the gravity drain system (Fig14, 15).

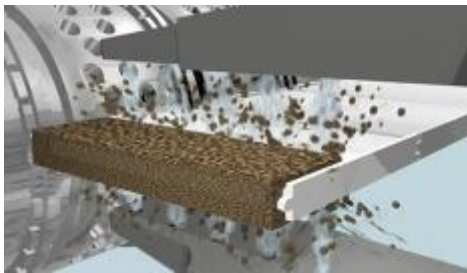

Figure 14

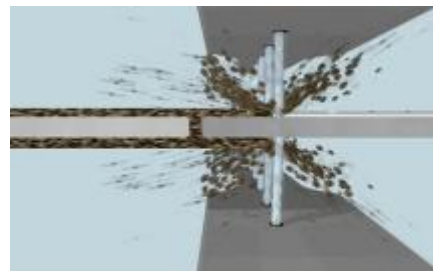

Figure 15

After each row of cassettes is cleaned (Fig16) the nozzle unit slightly changes position, the control unit commands the index assembly to turn the cartridge until the next row is positioned against the nozzle unit (Fig17), ready to start cleaning the new row and so forth (Fig18,19).



Figure 16



Figure 17

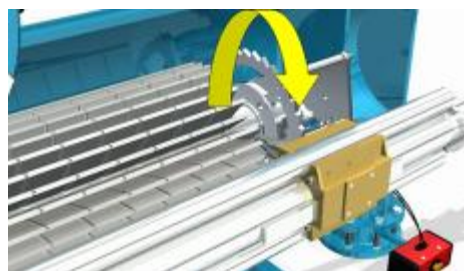

Once the cleaning of all the cassettes is completed, the flush and the drain control valves are closed (Fig20) and the inlet and the "filter to waste" control valves are opened (Fig21).

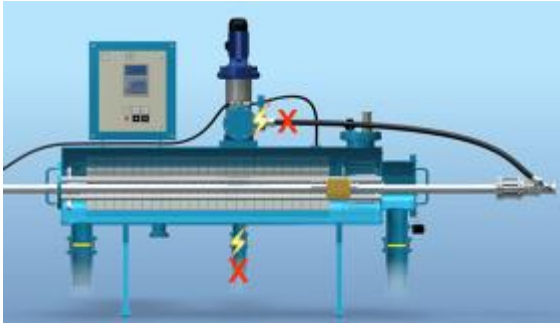

Figure 20



Figure 21

Raw liquid enters the filter and fills it up and initial filtrate is passed through the "filter to waste" control valve (Fig22).

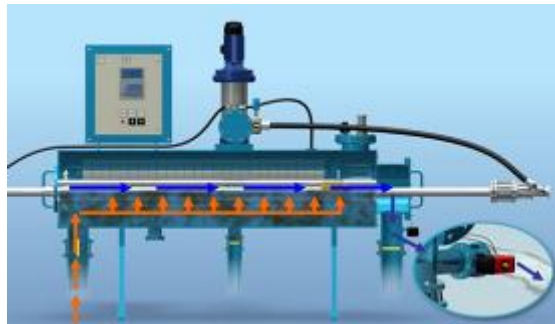

Figure 22

The "filter to waste" control valve closes (Fig23) and afterwards the outlet control valve opens. Finally the flushing pump is turned off (Fig24).

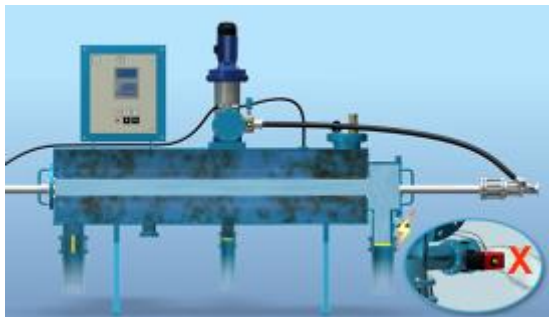

Figure 23



Figure 24

The filter is now back on-line.
The cleaning cycle takes approximately 10 minutes.

2. Installation

2.1. Pre-installation requirements

Amiad's AMF 370K-S filter is used for various water filtration applications and therefore can be installed in different types of installation sites; therefore prior to the actual installation of the filter it is important to make sure that the installation site meets the following criteria and requirements:

2.1.1 Floor area and surface

- The installation site area should be large enough to allow:
 - Access for performing regular maintenance procedures safely
 - Removal of filter components in case that disassembly of the filter is required
 - Installation of additional filter units if expansion of the filtration system is required
 - Installation of platforms and safety barriers to enable easy access to the filter without climbing on pipes and other equipment
- The installation site should be properly drained by providing sufficient floor gradient and preventing standing water accumulation
- The installation site should be properly lighted for good visibility and safe maintenance

2.1.2 Power supply

- Rated operation voltage - 3 Phase, 220 - 480 V, 50 / 60 Hz. Please consult your Certified General Arrangement Installation drawings for details
- Power consumption – 12 KW
- Power connection to the pump:
- In cases where the pump power supply is not pre connected by the factory, connect the pump to the control panel by means of a cable of 4 x 2.5mm² for a distance of up to 10m. Consult Amiad for cable specifications for distances longer than 10m. (In any case the user is responsible that this installation meets or exceeds the local or the national electrical codes; this is a "high" voltage connection).

2.1.3 Water supply for filter flushing

For proper removal of the filter cake without causing damage to the filter media, it is mandatory for the filter flushing process to use clean filtered water only. Therefore, the filter's flushing pump should be connected to a filtered water source capable of supporting a flow-rate of 20m³/h (88GPM).

In a single filter installation the flushing water source may be one of the following options:

- In cases where the filter is installed upstream of any type of water storage facility such as reservoir, water tank or water tower, a supply line can be installed between the clean water storage and the filter for feeding the filter's flushing pump with filtered water.
- In cases where the filter is connected directly to the end-users' pipeline, a designated flushing water tank should be installed in the filter vicinity. This tank is connected to the downstream outlet of the filter and is filled-up during the regular operation of the filter in order to serve as the flushing pump's water source during the flushing process. The minimal water storage in such tank should be – 3 m³ (800 gallon)

2.1.4 Drainage system

- A gravity-flow drainage pipeline should be provided at the installation site.
- It is mandatory that the diameter of the drainage pipeline will be at least at the same size of the filter's original drainage manifold.
- The drainage pipeline should be opened to the atmosphere within the first 0.5 meter fall below the filter housing bottom line.
- No restriction is allowed on the drainage pipe.
- Do not raise the drainage pipeline above the filter housing bottom line.
- It is necessary to prevent vacuum buildup in the filter during the flushing cycles, therefore it is recommended to install a 1.5" vent pipe on the drainage pipeline.
- Make sure that the entire drainage system is flushed and clean before connecting it to the filter.

2.1.5 Compressed air supply

- Dry and lubricated 6-7 BAR (90-105 PSI) standard compressed air supply is needed for the filter operation.
- In case where compressed air supply is not available at the end-user's site, a portable 8 bar / 100 liter compressor should be installed near the filter
- In cases where the user provides the compressed air supply, it is the user's responsibility to install a quick pressure release valve protecting the filter from higher than 8 bar excessive compressed air pressure.

2.1.6 Filter tune-up tool

In order to properly carryout the filter commissioning and the first start-up procedures, a clean and straight 4.5 meter 0.5" pipe (or rod) should be prepared at the installation site. This pipe is needed for pushing one of the filter pistons to its start-up position during the commissioning process.

Note: - For any further information needed for proper designing of the installation site please contact Amiad's Engineering Applications Department.

2.2. The Installation Process

2.2.1 Post shipment inspection

Before installing the filter it is necessary to inspect and verify that no damage had occurred during the shipment to the installation site. Please perform the following procedures:

This task should be done by a competent technician according to the following instructions, do not attempt to commission the filter unaccompanied.

Filter housing inspection for foreign objects and broken components:

Please note that for proper packaging the Piston house (1), High pressure pipe (2), Control tube & Proximity switch (3) are disconnected from the filter for the shipment.

1. Unscrew and remove the Piston#100 Protection Bar and cardboard, they are used for securing the piston during shipment.

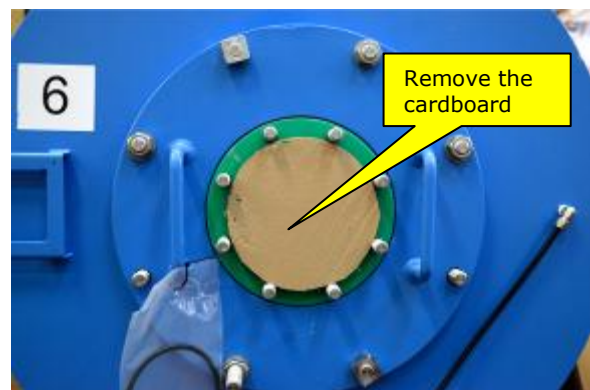
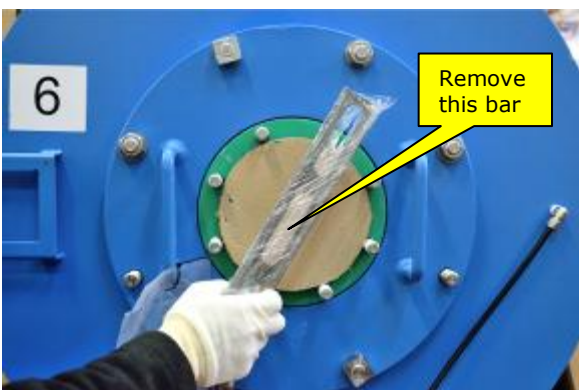
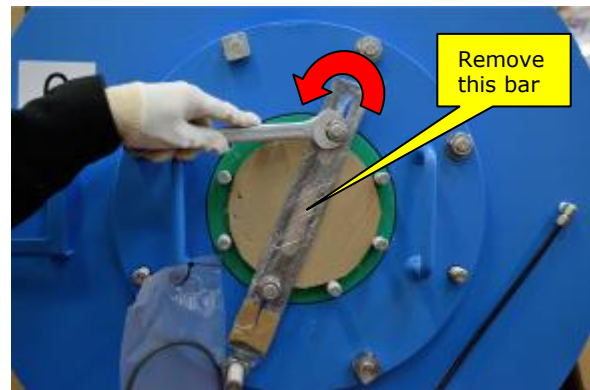
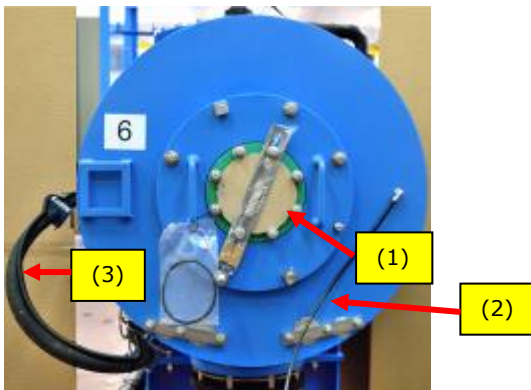

2. Remove Piston#100 by pulling it straightly and firmly out of the filter. Remove the plastic bag with the seal.

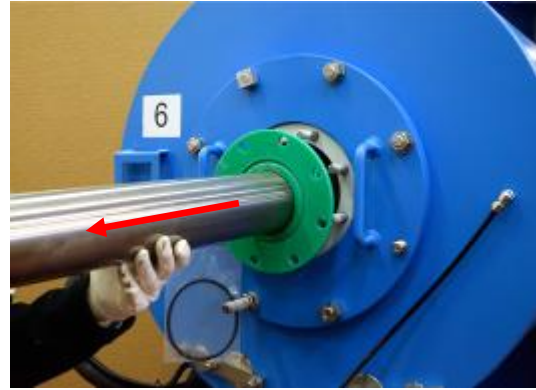

3. Unscrew the filter's cover long bolt **but for safety reasons do not remove its nut!**

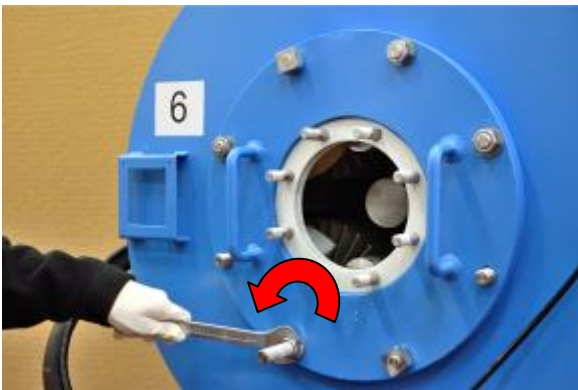

4. Unscrew and remove the hexagon nuts from the filter's Cover bolts. **Do not remove the long bolt nut!**

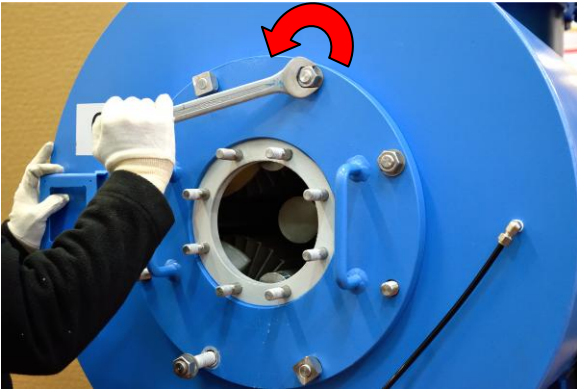

5. Unscrew and remove the two centralizing square nuts from the filter's Cover bolts.

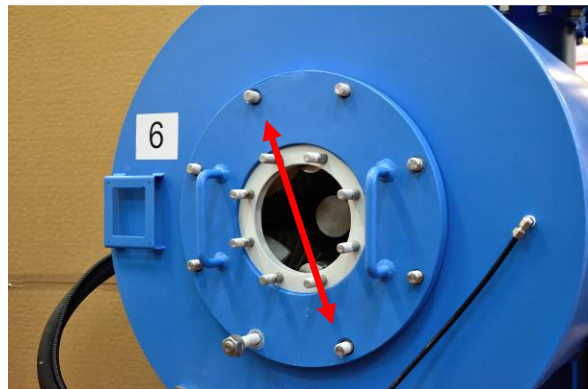
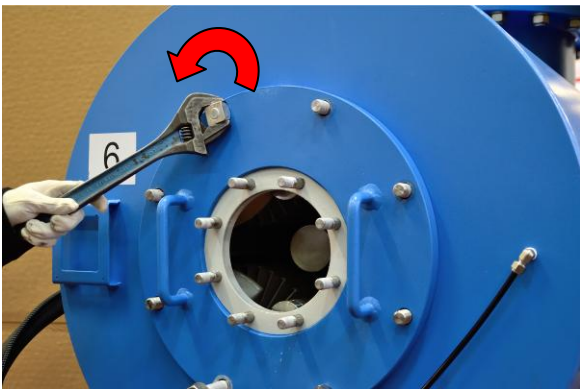

6. Open the cover by pulling it and carefully, leave it to hang on the long bolt. **Do not remove the long bolt's nut!**

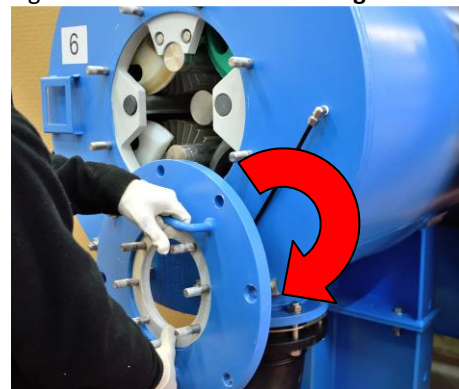

7. In preparation for removing the #76 piston turn the cartridges plastic covers an align them as depicted in the following pictures.

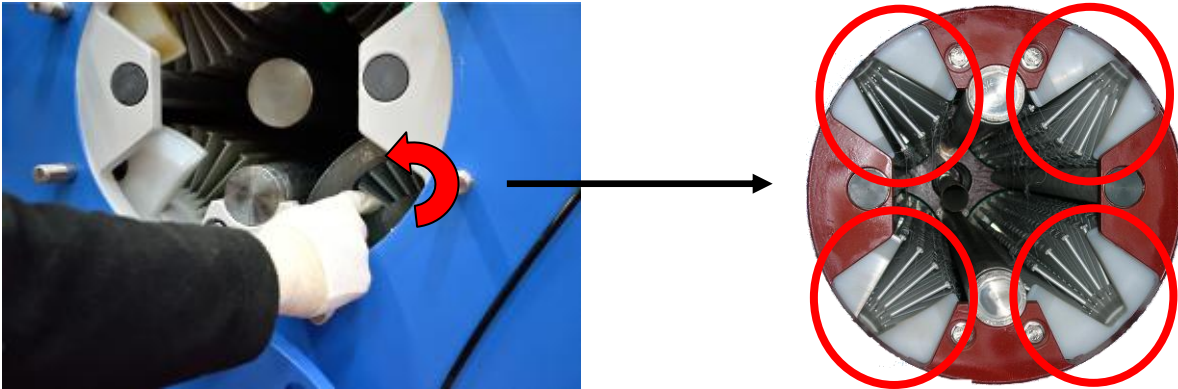

8. Remove Piston#76 by pulling it straightly but gently out of the filter. Make sure not to damage the cassettes by letting the spray nozzles to hit the cartridges while pulling the piston (**you may need assistants to keep the piston balanced while pulling it out**).

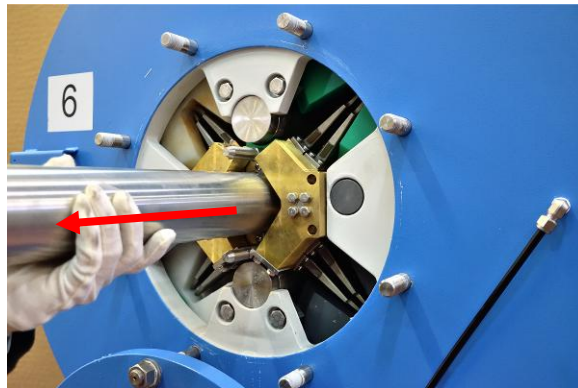

Important Note: While pulling out Piston#76 please note and mark the lower side of the Bearing-Slide. When reassembling the filter it is recommended to insert the piston with the same side of the bearing facing down.

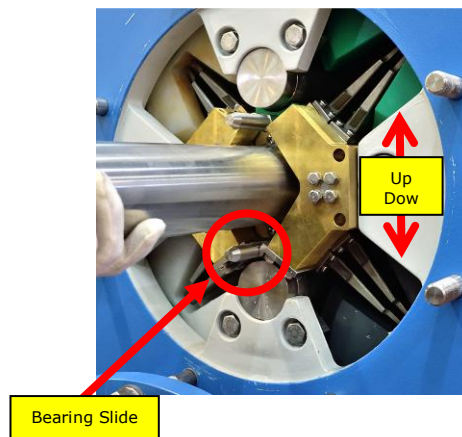

- Using a flashlight inspect the interior of the filter and remove any foreign objects that may entered the filter housing during shipment. **Inspect the cartridges and in case that loosen or fallen cassettes are found do not proceed with the installation and contact your supplier immediately.**

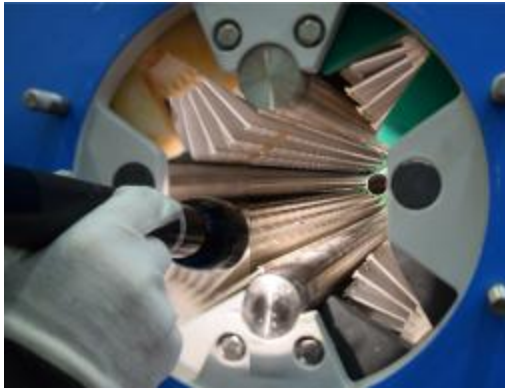

Piston assembly:

- Make sure that the V-shape plates of the cartridges point to the central line of the filter, if necessary turn them by hand accordingly.

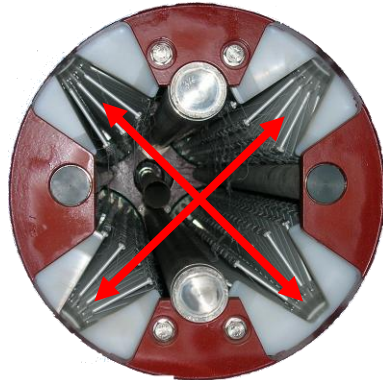

- Gently insert Piston#76 back to its original place. Make sure that the following three points are met:
 - The piston is inserted over the Tail Pipe Assembly located in the center line of the filter.
 - The spray nozzles are gently inserted in the gaps between the cassettes' rows and are not hitting the cartridges while the piston is pushed in.
 - The side of the Bearing-Slide that is facing down is the same side that was facing down during the disassemble process of the piston.

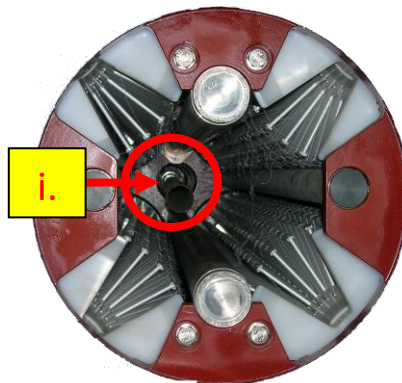

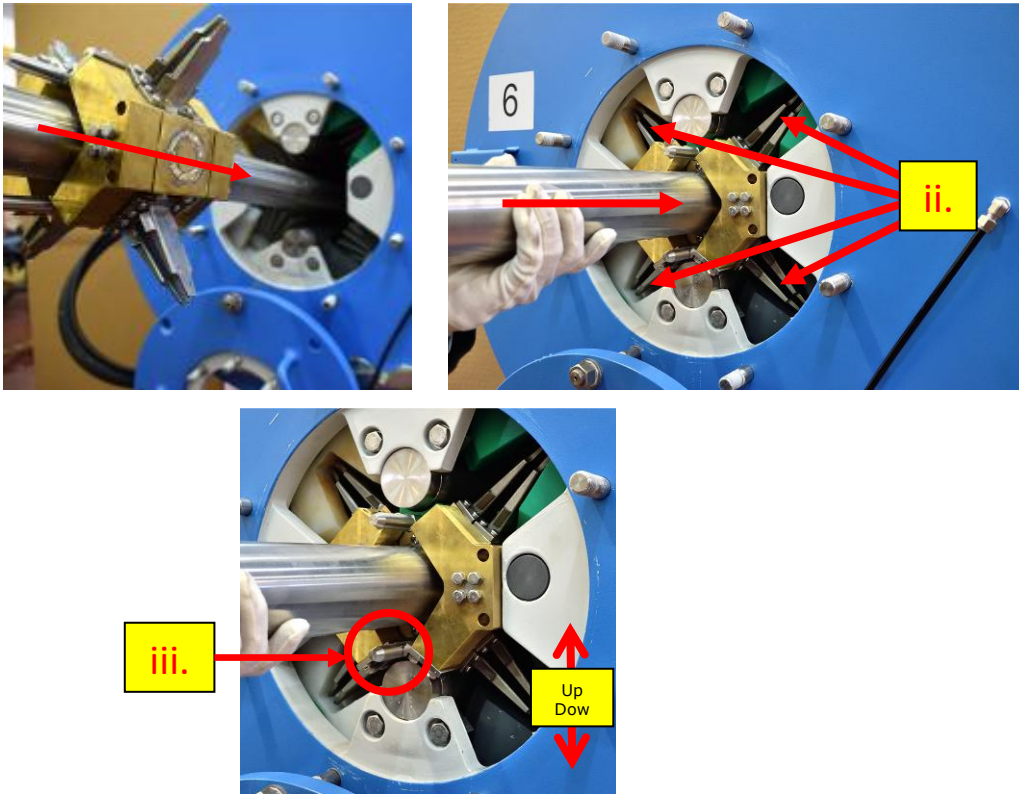

3. Gently Push Piston#76 into the filter so it will not stick out of the filter housing.



4. Close filter's Cover and re-screw first the centralizing square nuts, this makes sure that the cover is correctly seated in place.

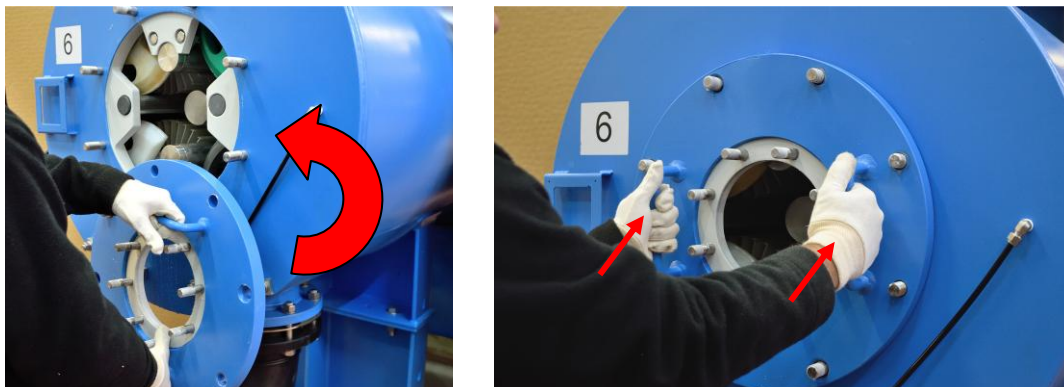

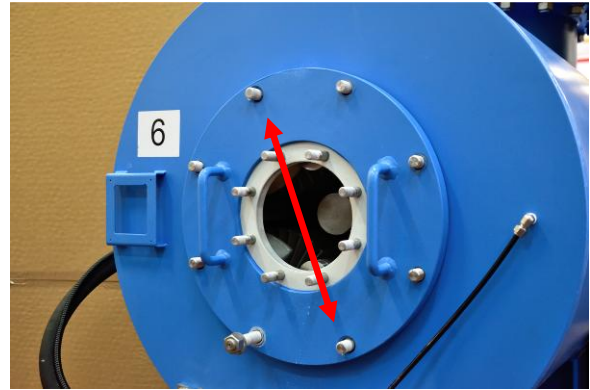
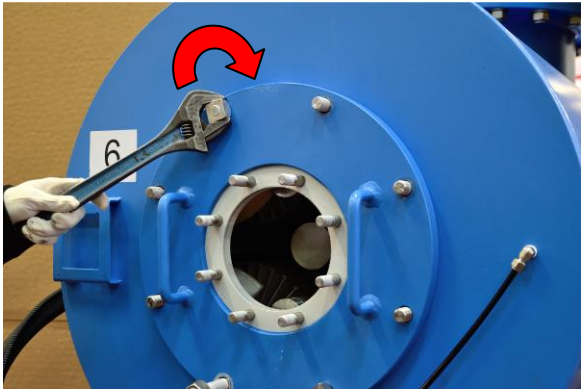

5. Re-screw the Cove's hexagon nuts.

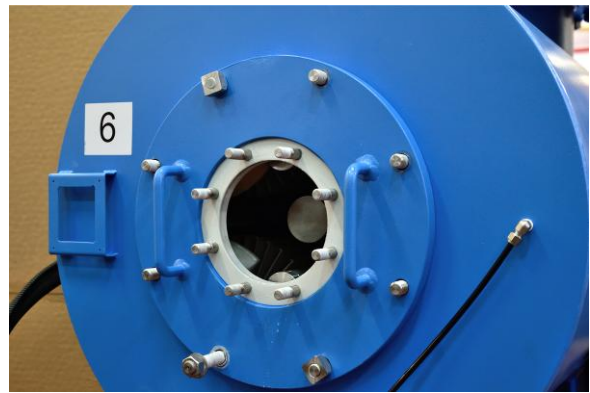
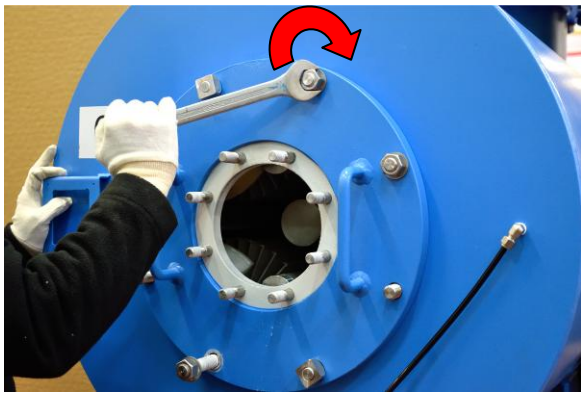

6. Perform the following visual check and verify that all the 35 cassette rows in all cartridges are aligned:

Remark: This procedure should be done after each time the cartridge is inserted into the filter and before the initial startup.

- a. Pull out the inner piston.
- b. Turn the cartridges full turn
- c. Using torch light make sure that all cassettes are aligned in all rows.

Important: Starting a flush cycle where some cassettes are out of line (see the following pictures) will damage the cartridge!

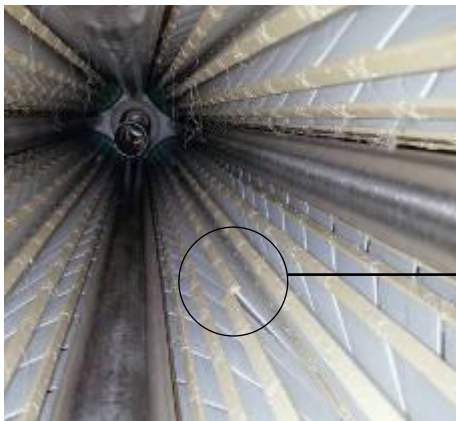

Inspect and re-tight all bolts:

Visually inspect the filter for loosened bolts, especially verify and re-tight the bolts of the entire filter covers.

Make sure that the filter is disconnected from any electrical power source; carefully open the control panel cabinet and re-tight the bolts of the terminal strips.

Re-tight the screws
of the terminal strips



2.2.2 Separately supplied additional filter parts assembly

Due to packing and shipping restrictions some of the filter parts are disconnected in the factory from the filter and packed separately after finalizing the quality control procedures and the factory complete test-run of the filter. These parts should be re-connected to the filter at this stage of the installation process.

In most of the cases the main part to be re-connected is the piston housing.

This task should be done by a competent technician according to the following instructions, do not attempt to commission the filter unaccompanied.

1. Insert Piston#100 over Piston#76 and push it into the filter until the Green Insert Interface Plate is inserted on the Intermediate Cover bolts. Make sure that the following three points are met:
 - i. Piston#76 is inserted into Piston#100.
 - ii. One of the round holes at the Gide Cylinder is pointing upwards.
 - iii. The Green Insert Interface Plate has an O-ring on its inner side.

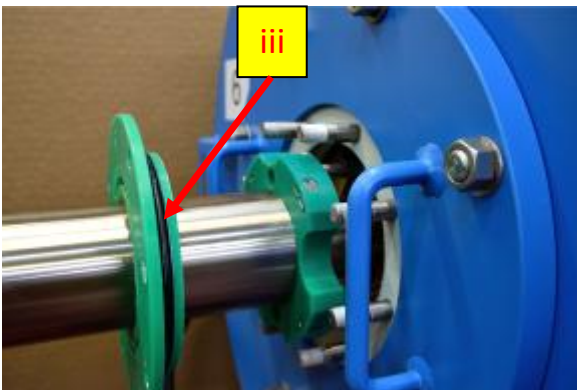
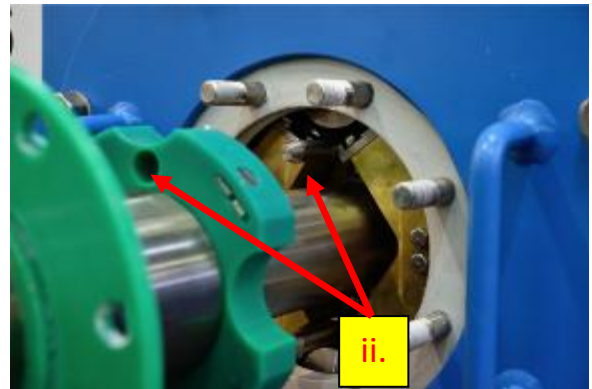

2. Insert the outer seal to its groove in the outer side of the Green Insert Interface Plate.



3. Insert the Piston House Assembly and screw its bolts firmly.

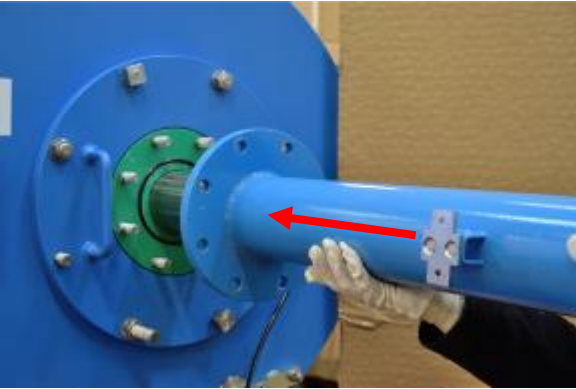

4. Connect the High Pressure pipe to the far end of the Piston House Assembly and secure it by connecting its U-shape support to the piston housing.



5. Connect the control tube to the Piston House Assembly.



6. Connect the Proximity Switch SW1 to the Piston House Assembly by screwing the sensor to its Mounting block. **Do not move the Mounting Block!**



2.2.3 Positioning the Filter

The filter should be positioned and connected according to its Certified Installation Arrangement Drawing. This drawing specifies the layout of the filtration site as prepared by qualified engineers according to Amiad's Application Engineering Department specifications.

Please study your Certified Installation Arrangement Drawings and then position the filter and mount it to the floor area according to the drawings, please take extra care and exercise the relevant safety instructions.

The following drawing (Fig25) is an example of such Installation Arrangement Drawing. **It does not replace your certified drawing** and it is given here for broadening the end-use knowledge only.

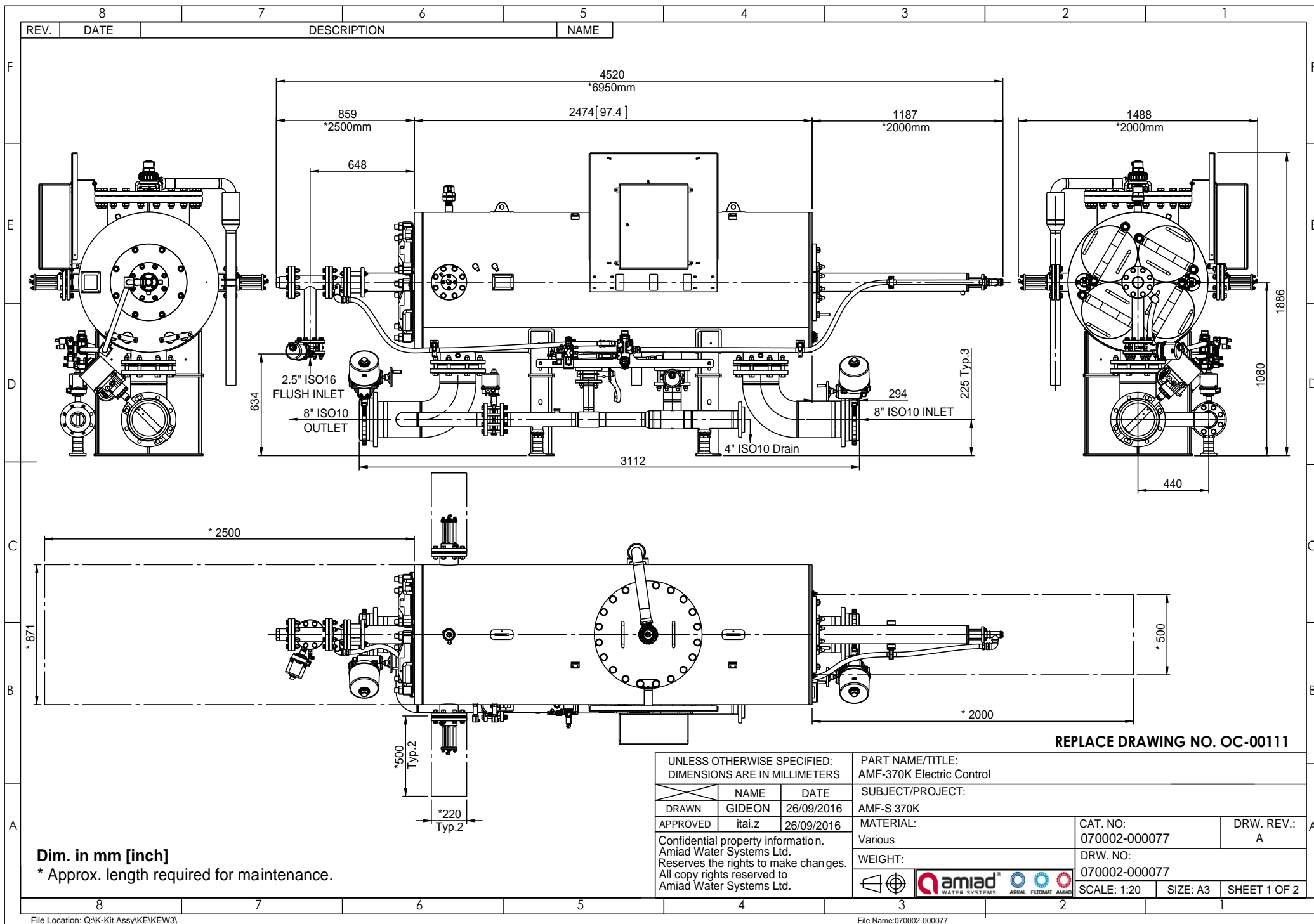
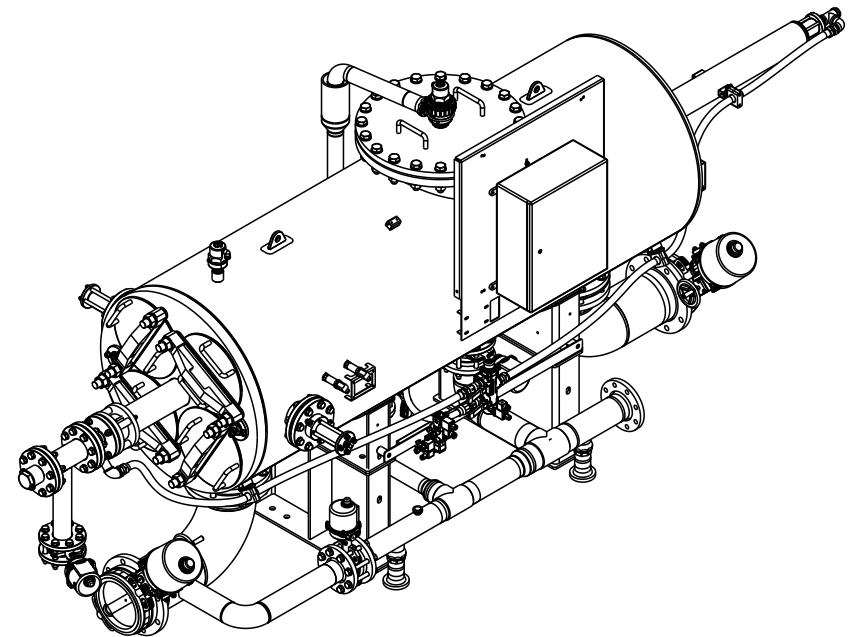
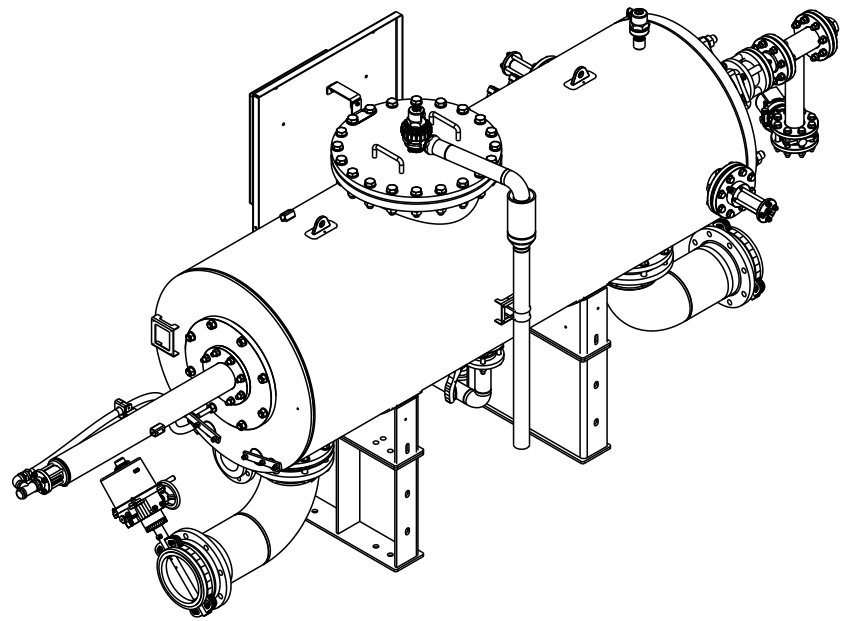

Figure 25



REPLACE DRAWING NO. OC-00111

UNLESS OTHERWISE SPECIFIED: DIMENSIONS ARE IN MILLIMETERS		PART NAME/TITLE: AMF-370K Electric Control	
		SUBJECT/PROJECT: AMF-S 370K	
DRAWN	GIDEON	DATE	26/09/2016
APPROVED	itai.z	DATE	26/09/2016
Confidential property information. Amiad Water Systems Ltd. Reserves the rights to make changes. All copy rights reserved to Amiad Water Systems Ltd.		MATERIAL:	Various
		WEIGHT:	1691 KG
		CAT. NO:	070002-000077
		DRW. NO.:	070002-000077
		SCALE:	1:20
		SIZE:	A3
		SHEET 2 OF 2	

2.2.4 Pipeline connections

After the filter is positioned and secured to its designated location consult your Certified Installation Arrangement Drawings and connect the filter to the pipeline network. In general the filter should be connected to the following points:

- Upstream pipe – the entry point of unfiltered water to the filter
- Downstream pipe – the exit point of clean water from the filter and the connection point to the end-user's system
- Drainage system – a manifold exit point for flushed filter cake and “filter to waste” water
- Flushing pump supply – the entry point of clean filtered water to the flushing pump

It is necessary to prevent static backpressure or reverse flow through the filter and therefore it is recommended to install a non-return valve at the outlet of the filter.

It is necessary to protect the filter from excessive line water pressure, therefore the user is required to install a quick pressure release valve to ensure that the filter is not exposed to higher than 10 bar water pressure.

Note - Make sure that all pipe connections are bolted and secured properly according to the standards and the good water works practices.

2.2.5 Power Supply– Electricity and Pneumatics (if applicable)

The filter's Power and if applicable its Compress Air connections are described in a set of certified drawings prepared for your filtration site by Amiad's Application Engineering Department according to the required specifications.

Please study these drawings and then ask your qualified electrician to connect the appropriate protection devices and the electrical cables to the control unit of the filter.

When applicable connect the compressed air supply to the appropriate terminals in the filter solenoids' cabinet according to your certified drawings.

Important notes:

- **Do not switch on the power and the compressed air supply at this stage!**
- **Switching on these systems prior to the commissioning procedure of the filter may cause damage!**
- Please take extra care when connecting the power and the compressed air to the filter, always exercise the relevant safety instructions

The following pictures show a typical Electrical Wiring Connections. They **do not replace your certified drawings** and are given here for broadening the end-use knowledge only.

The Sub-Master Control Panel



The Slave Control Panel

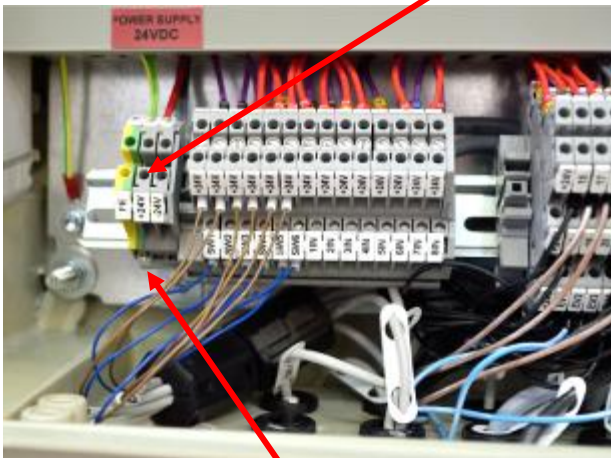

Main Power Supply
Connection terminal



Communication
Connection terminal

3. Description of the control panel

3.1. Introduction

Amiad's AMF 370K-S filter automatic operation is carried out and controlled by a control panel. The control panel consists of electrical, electronic and when applicable pneumatic components. All these components are integrated and installed in the control-panel's enclosure that is mounted to the filter housing at an easy to access position. The control panel may include two Cabinets: PLC cabinet and the when applicable a Solenoids Cabinet. The master control board serves also as the filter's user interface allowing the user to monitor the filter operation and to adjust certified operation parameters and set-points.

3.2. Components mounted on the control panels doors

In order to provide the end-user with an easy to use user interface several control elements are mounted on the outer and inner doors of the control panels enclosures.

The **Slave Control panel** enclosure:

Switches:

- MAIN SWITCH – used to switch On/OFF the main power supply
- MANUAL/OFF/AUTO selector switch – used to set the flushing pump operation mode

Lamps:

- POWER ON lamp – indicates the status of the filter's Power Supply
- FAULT red signal lamp - lights on when the system is in Fault Mode
- CYCLE ON green lamp – lights on when the filter is in Flush Mode

Push buttons:

- Emergency STOP CYCLE push button – used to stop the flushing cycle in emergency situations

Display panel:

- PLC DISPLAY PANEL – used to read various status data and enter set points

3.3. Internal components of the control panels

The rest of the control panels components' that are not related to the user interface are mounted inside the control-panels enclosures according to the IP65 standard. Accesses to these components is allowed only to qualified by Amiad technicians who are familiar with Amiad's "AMF-control panel description.DOC" and other Amiad technicians' text books.

It general the internal components of the control panels include elements such as: Power supply elements, PLC units and extension components, Fuses, Circuit breakers, Overloads, Relays and Solenoids and other similar control elements. The following drawing (Fig26) is a general purpose demonstration drawing of the control components. This drawing does not replace your certified drawings and it is given here only for broadening the end-user's knowledge.

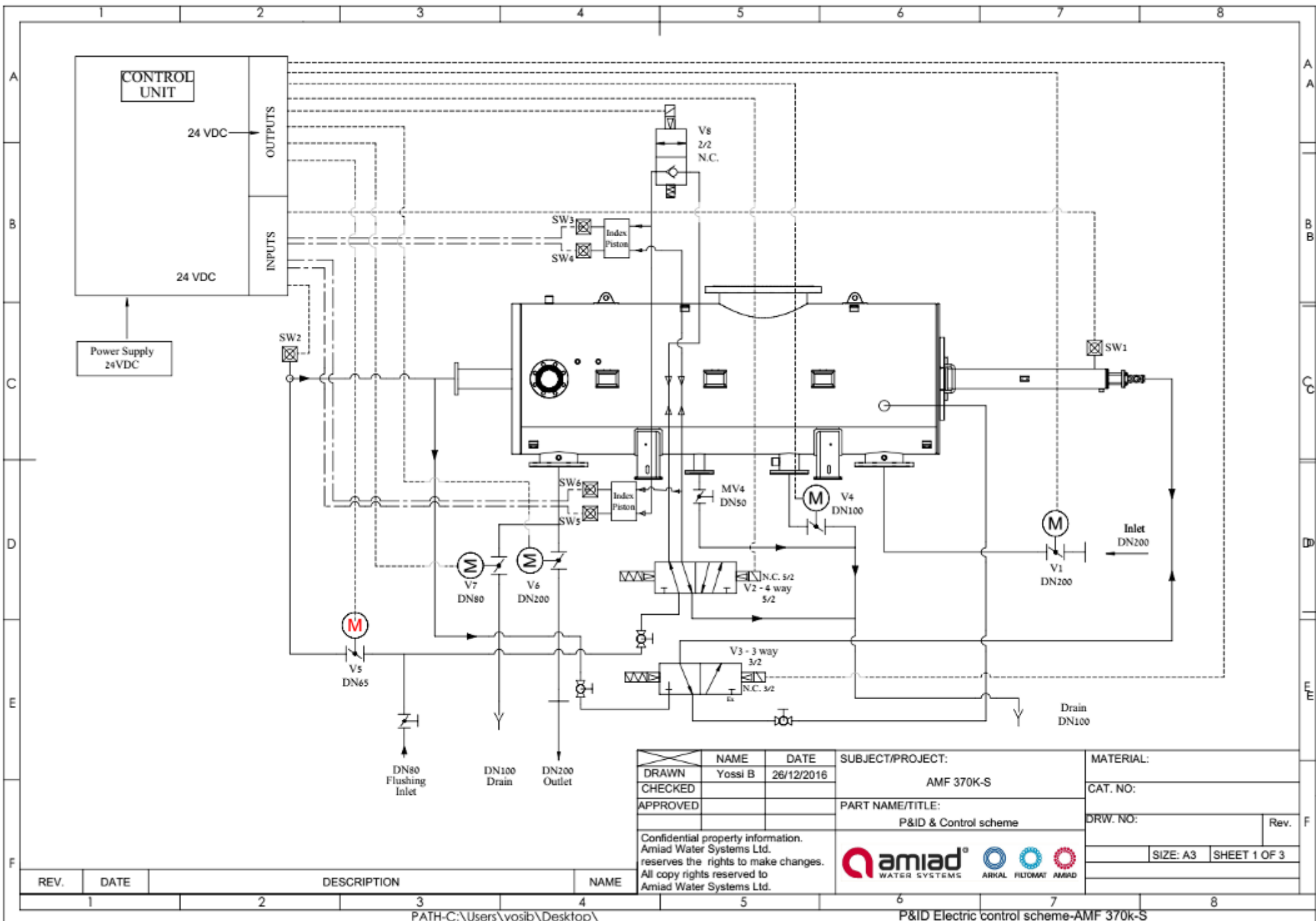

3.4. Basic operation of the PLC

In order to operate the filter it is absolutely important for the user to be familiar with the operation method of the PLC through its HMI display as described in this chapter.

It is also very important for the user to understand the system status terminology, especially it is important to distinguish between the following 3 terms:

- **System Fault** – a major malfunction of one (or more) of the system components that caused the whole system to halt.
- **System Alarm** – a second level notification indicating a malfunction of one (or more) of the system components. In multiple filters installation this may indicate a malfunction that stopped one of the filters while the rest of the system filters continue to work. In a single filter installation such malfunction leads immediately to System Fault.
- **System Attention** – a malfunction of one (or more) of the system components that was overcome automatically by the control system of the filter. For the user knowledge only.

The electronic control system of the AMF 370K-S filter consists of two major components:

1. The PLC – Siemens S7-1200 PLC; this component contains the operational algorithm of the filter and is responsible for its actual operation. It is important for the user to understand that once running the PLC software operates the filter independently; even without being connected to any user interface device. The PLC software contains internal default values for all the required operation parameters and once it is connected to power supply it operates the filter.
2. The HMI panel – This component serves as a user interface device connecting between the internal PLC software and the user and allowing data exchange between the PLC and the user. Amiad provides several HMI panels to be connected to the Siemens PLC; the selection of the appropriate panel depends on the specific filter, project or site requirements. This document describes the Amiad HMI software based on Siemens KTP-700 7” panel.

3.4.1. Basic operation of the panel

The Siemens panel is a touch screen panel; it contains no keyboard and its operation is done by touching graphical elements appearing on its screen.

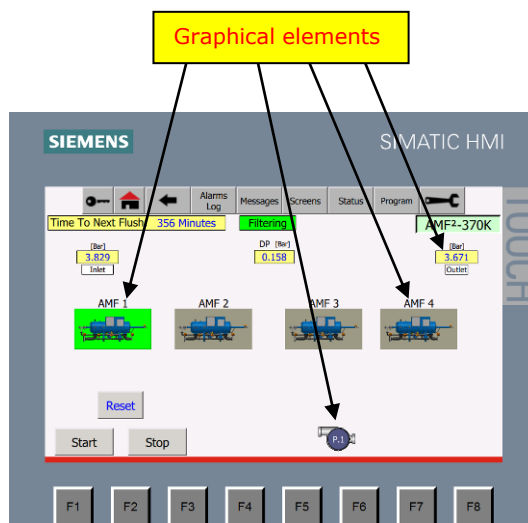

While operating the unit it is important to be aware of the following general issues:

- Unintentional actions - Unwanted actions may be triggered if the operator unintentionally touches several graphic elements (keys) at once. Never press more than one element at a time.
- Screen damage - Operation of the screen with hard, pointed or sharp objects or hard impact may lead to a considerable reduction of the service life and even to complete failure. Always use your fingers to operate your HMI device.
- Help Screen – Whenever a question mark key [?] is shown on the screen a help screen is available. Press and **hold** the [?] key in order to read the help screen.

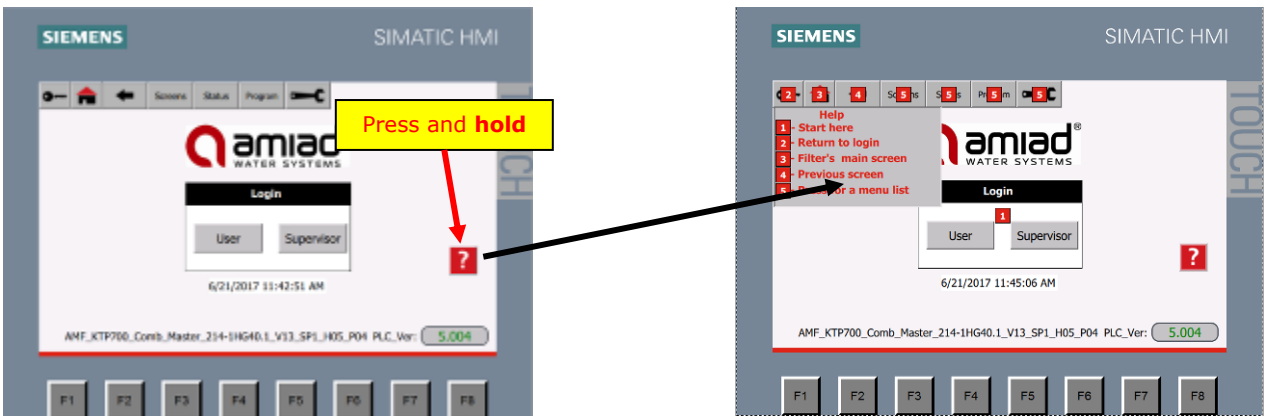

- Data entry – since the HMI panel doesn't have a physical keyboard, a virtual keyboard is displayed automatically whenever the user presses a graphical element which requires data entry. The following picture shows the virtual keyboard:

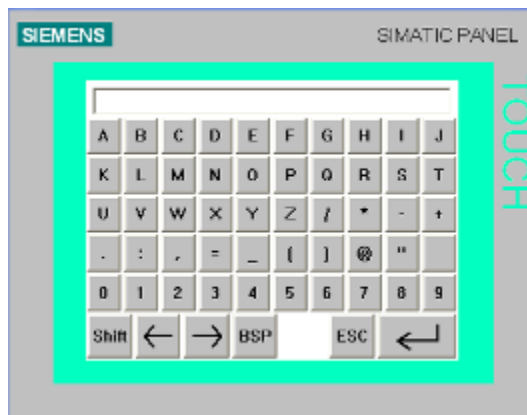

The Virtual keyboard contains the following keys:

- Entry line – across the upper border of the screen
- Alphanumeric keys – in the middle section of the screen
- Navigation keys – across the lower border of the screen
 - Shift key (for uppercase characters)
 - Left and Right Arrow keys
 - Backspace key (BSP)
 - Escape key (ESC) for returning without writing
 - Enter key

- Logging into the system - The HMI panel may be operated by three types of users:
 - Regular user – no password is required for logging in as a regular user; the regular user can see all the screens and the data elements of the system but he cannot change any parameters.
 - Supervisor – A supervisor password is required for logging in; the supervisor can see all the screens and the data elements of the system and he can change all the parameters of the regular day to day operation of the filter, i.e. flushing “Time – Interval”.
 - Administrator – The administrator can see and change all the data elements of the system including changing the very sensitive filter configuration parameters. An administrator password is required in order to login as an administrator.

The following pictures show the main login screen and its operation.

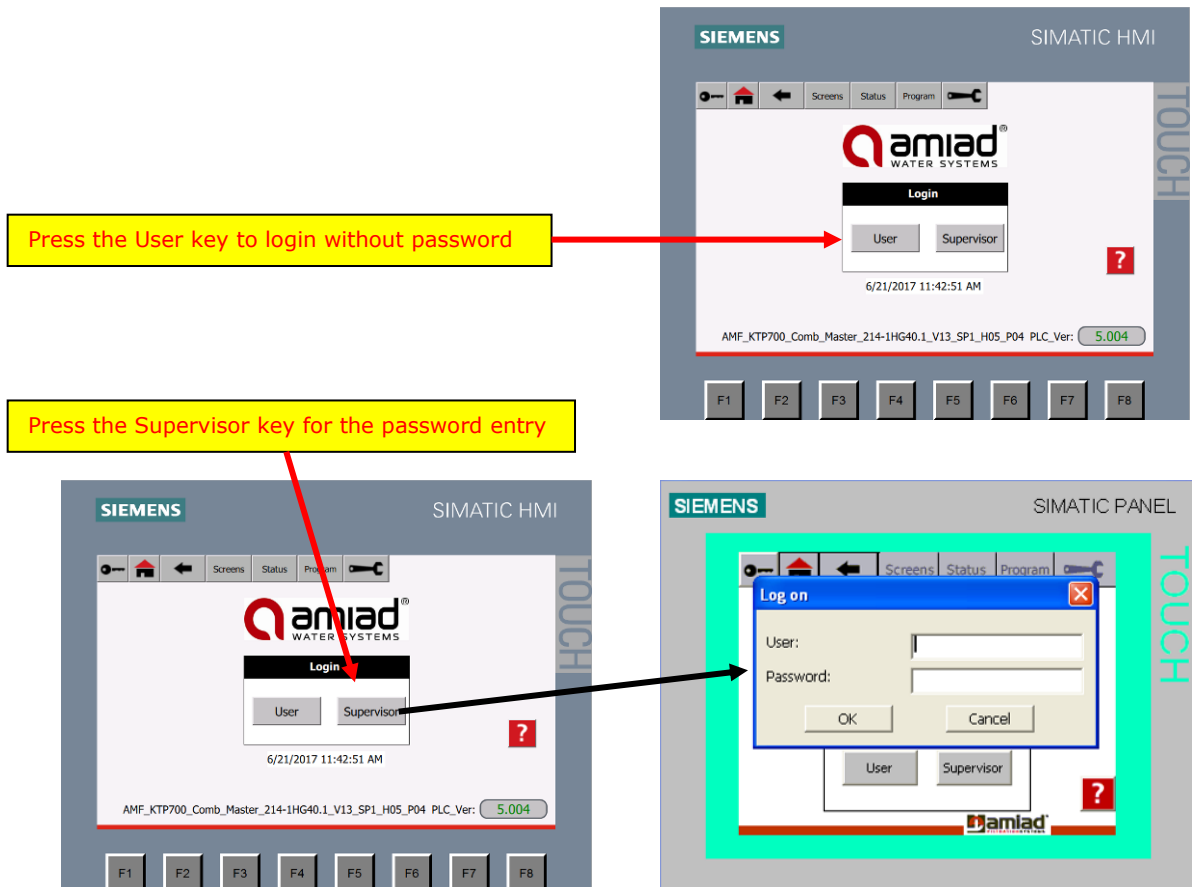

Your Supervisor user name is: super
 Your Supervisor password is: 9876
 Your Administrator user name is: _____
 Your Administrator password is: _____

Notes:

1. Please contact your Amiad representative for Administrator login details
2. Attempt to change an unauthorized parameter within the system opens the login screen

3.5. HMI operation principles

The HMI operation is based on the following main components:

- Menu bar – The menu bar appears across the upper border of the screen and is consist of rectangular keys. Some of these keys can perform a single operation, while the other keys when pressed open a vertical menu-list that contains other single operation keys.

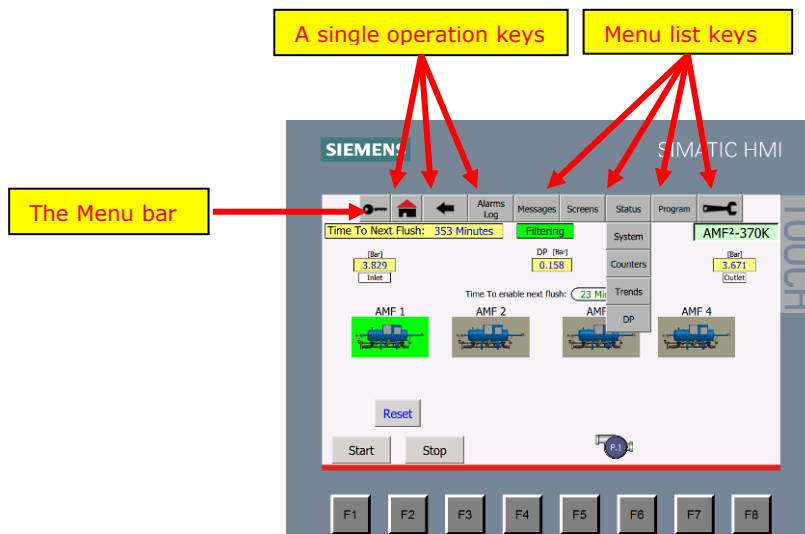

- Graphical Screens – Screens with pictures showing the filter or its parts. These screens show the various filter components in action. The color of the components and their motion across the screen is changing according to the operation of the filter in real time. Pressing on some graphical elements operate a zoom-in and the specific filter element is shown in details.

Graphical screens showing motion

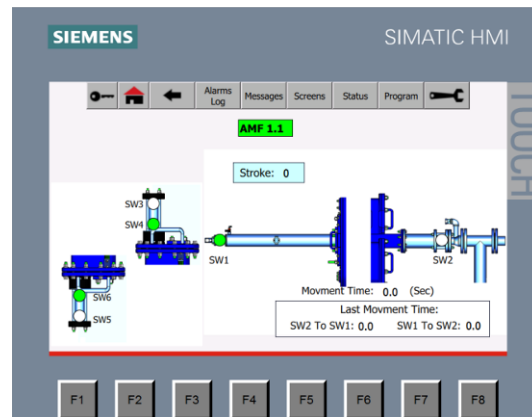
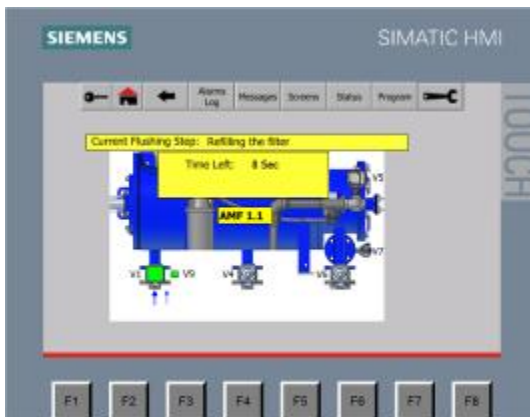

Press here (1) to zoom-in (2)

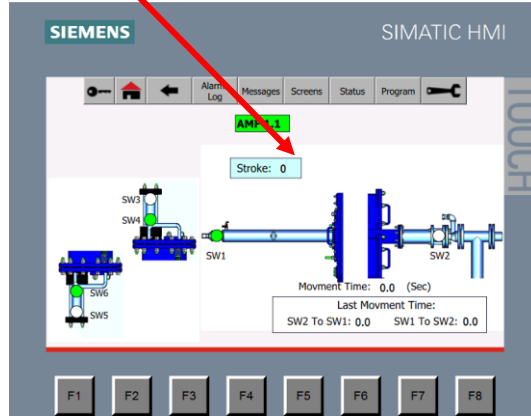
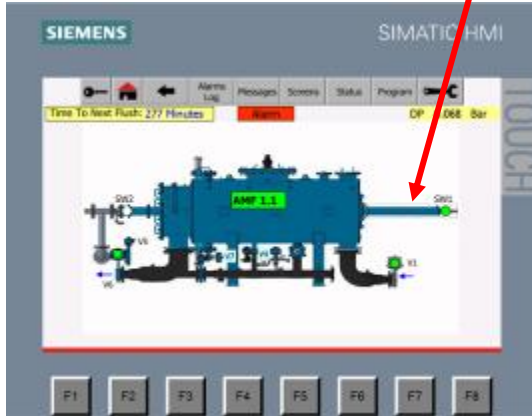

- Tables Screens – Screens containing a table showing alphanumeric data on various filter components, system messages or operation parameters. Some of these screens are for showing information only while other tables screens are for data entry (depends on a specific login authorization). **Please note:** Black color data items are for your information only while Blue color data items showing parameters to be adjusted by the system’s Supervisors and Administrators.

Status only table

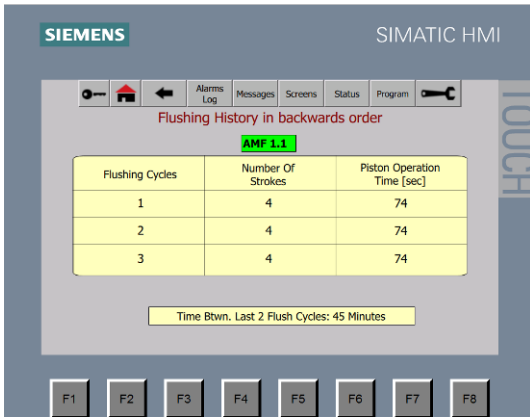

Parameters table

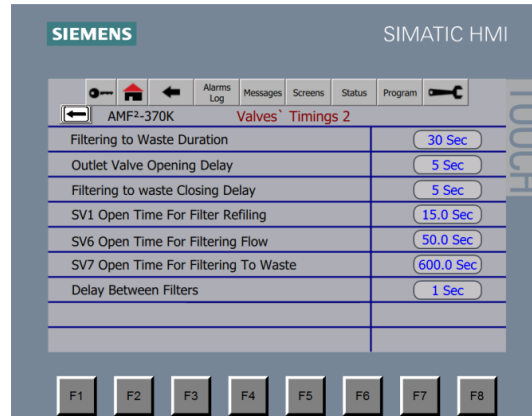

- On Screen Messages – These HMI components appear on the Graphical Screens near some filter components. The On Screen Messages show:
 - Status data regarding regular filter operation i.e. “Time to next flush” or current “DP reading”.
 - Error messages regarding faulty filter operation or components.
 All the On Screen Messages appear in black on a Yellow background. When pressing on an On Screen Message the system moves to the applicable Table Screen showing detailed information regarding that message.

Press this

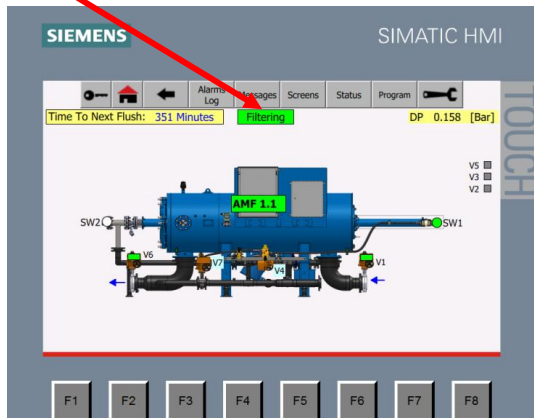

To get this

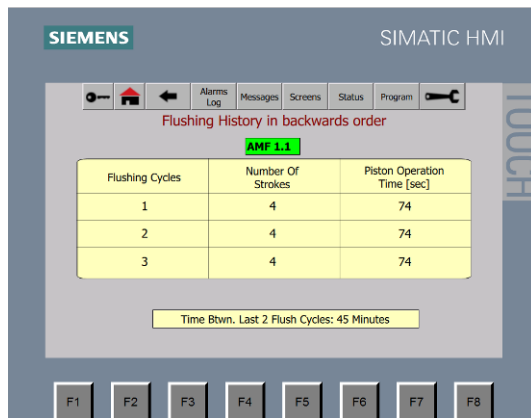

Press this

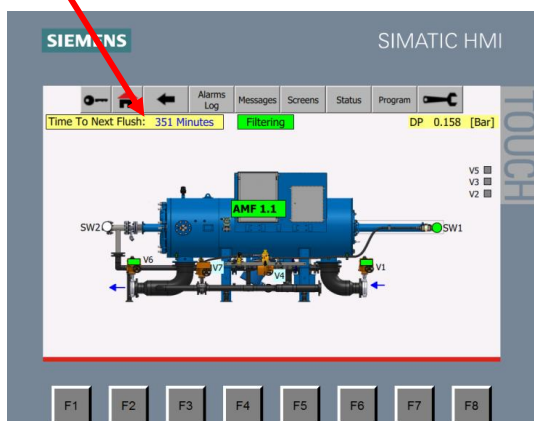

To get this



Press this

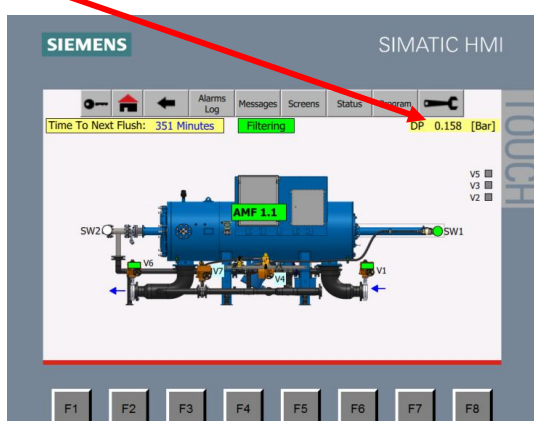

To get this

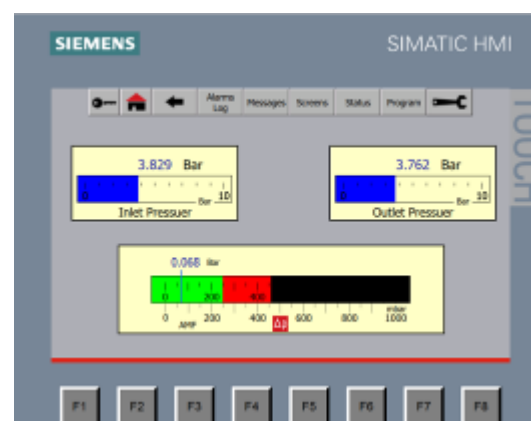

3.6. Finding your way within the system

There are several ways to move about the system and the user may even combine between them to his convenience:

Using the single operation keys:

There are three single operation keys:



The Login key – Pressing this key at any time or from any screen moves the system back to the login screen. The user may use this key in order to return to the entry point of the system or for switching between user types (User, Supervisor or Administrator).



The Home key – Pressing this key at any time or from any screen moves the system back to the main screen of the filter. The main screen (the Home screen) is the first graphical screen shown immediately upon completion of the login process. This is the entry point to the actual operation of the filter. The user may use this key whenever he likes to return to the beginning. **Please note** that the main screen gives the current general status of the filter.



The Back Key – Pressing this key at any time or from any screen moves the system to the previous screen, much like the “go back one page” of a regular Internet browser.

Using the Menu lists:

The menu lists are groups of single action screens that fall into the same category. There are four menu list groups:

- Screens – This group contains the entry points to all the graphical screens of the system. In order to jump to a specific graphical screen press the [Screens] key and choose your desired screen from the list, i.e. Piston, Index, etc.
- Status – This group contains the entry points to all the status table screens of the system. In order to jump to a specific status screen press the [Status] key and choose your desired screen from the list, i.e. System status, Messages, etc.
- Program – This group contains the entry points to all the program table screens of the system. In order to jump to a specific status screen press the [Program] key and choose your desired screen from the list, i.e. Set Points or Set Time.
- Tools – This group contains the entry points to all the tools and configuration table screens of the system. In order to jump to a specific configuration screen press the  key and choose your desired screen from the list, i.e. Config., Set up, Valves, etc.

Using the Graphical screens:

The graphical screens contain drawings of the filter; the user may press on any working element of the filter in order to zoom-in to that element specific screen. Please note that in the main screen (home screen) it is possible to rotate the filter clockwise and contra clockwise in order to reach the elements at the other side of the filter, i.e. rotate the filter out of the front view in order to reach the flush pump at the rear view of the filter.

Using the On Screen Messages:

Use the On Screen Messages to jump to their relevant table screen. This option is very useful when tracking the reason of a filter fault; the user may press the fault message in order to jump to the system messages screen for additional information regarding the fault.

3.7. Changing the HMI language

One of the HMI features is its multilingual ability; the user can change the interface language on-the-fly by selecting the required language at the Tools / Language Menu.

The language changing screen displays national flags of the countries whose languages are available at the HMI system, in order to change the language the user have to select the appropriate flag at this screen.

The following picture shows the language changing screen:



Important Points:

Finding the language changing screen:

It is possible that the user doesn't know the current HMI language and he would like to change it to a different language when not being able to read the current menu entries.

This is why the label on the main menu's tools entry is the  icon, so it can easily be selected in any language. The language selecting screen is the first entry under the tools menu and in all the languages its label is "Lang."

The Hebrew language:

Since the Hebrew language is written from right to left, the regular left-to-right tables are not suitable for Hebrew. Therefore, when changing the language to Hebrew the system changes the tables' direction accordingly.

Please note that after a power failure the system returns to the last used language. If the language was Hebrew and after a power failure you notice that the tables' direction is incorrect please select the Hebrew language again.

UK versus US English:

The language of the UK and the US English in the HMI system is actually the same. The only difference is with the Pressure Measurement Units.

The UK English uses BAR while the US English uses PSI for the DP and the In/Out pressure meters.

Important Note: When changing between these two options the HMI changes the pressure parameters across the system according to the BAR or the PSI factory default parameters. Therefore if you use other than the factory default parameters, please recheck your entries after changing the pressure units.

3.8. HMI screens description

This chapter describes in detail the HMI screens divided into their categories:

3.8.1 Login screens

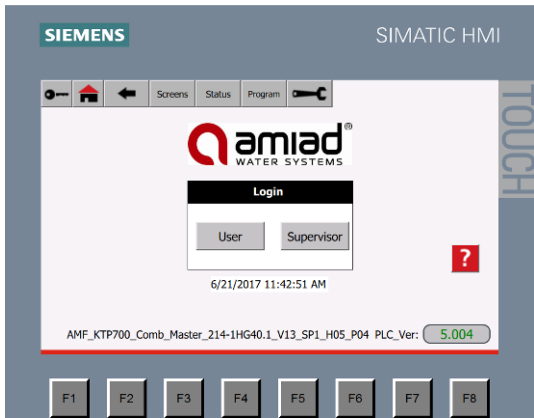
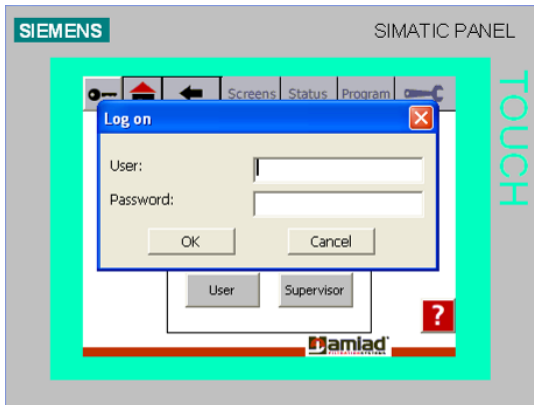
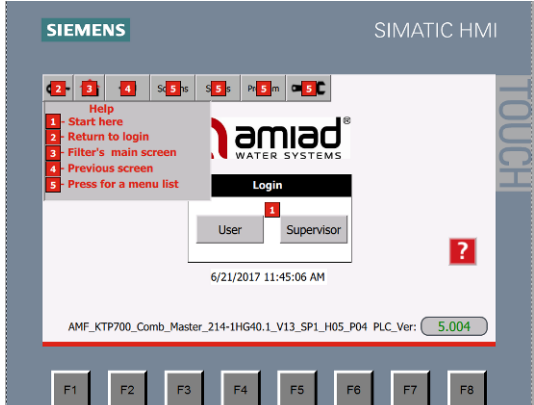
	<p>The Entry screen of the system – appears when power is applied to the system.</p> <p>This screen allows the user to:</p> <p>Select the user type:</p> <p>Press [User] to login as a regular user</p> <p>Press [Supervisor] to display the supervisor and the administrator login screen.</p>
	<p>The Login Screen</p> <p>This screen presents:</p> <p>The Administrator and Supervisor login window.</p> <p>Enter your Administrator or Supervisor user name and password to login.</p>
	<p>The Help Screen</p> <p>This screen presents:</p> <p>The help screen.</p> <p>Press and hold the question mark key in order to read the content of the help screen.</p>

3.8.2.1 Graphical screens - System

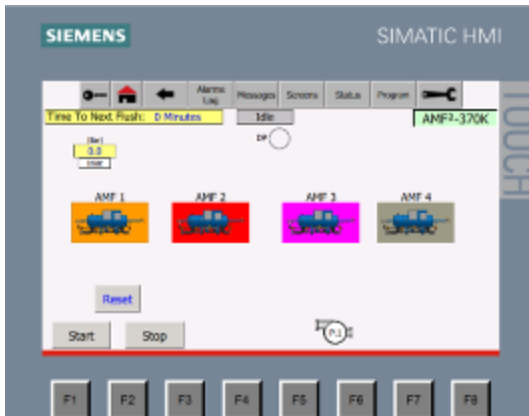
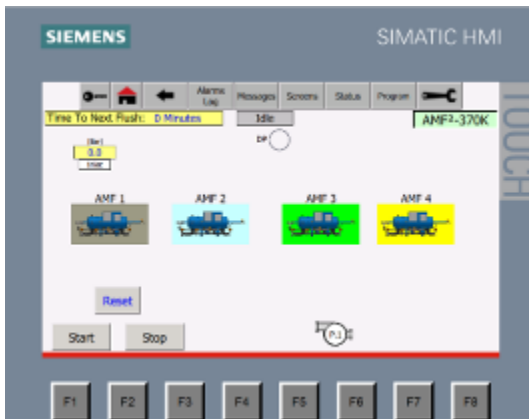
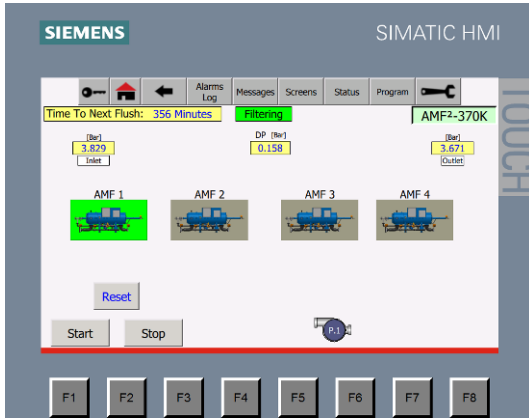

Main Screen - System (Home)

This screen presents:

The status of the system – in the upper middle box.

Adjacent to the status box the control panel ID is shown (AMF²-370K).

The time to next flush - in the upper left box.

The current DP reading – in the second line middle box.

The current Inlet and Outlet pressure readings are shown left and right of the DP box.

The filters Icons show the general status of the system's filters.

At the lower right side of the screen the system's pump is shown.

In the lower left side of the screen 3 buttons are shown; Reset faults, Start a flush cycle and Stop a flush cycle.

Press any filter icon to zoom-in to the specific filter screens.

Press any box to display the detailed relevant screen.

The filters Icons change their color according to the filter status:

Gray - Disabled

Pale Blue - Enabled but in standby mode

Green - Filtering

Blinking Orange - Active Alarm

Red - fault

Purple - CIP (when applicable)

The Menu List Screens - General

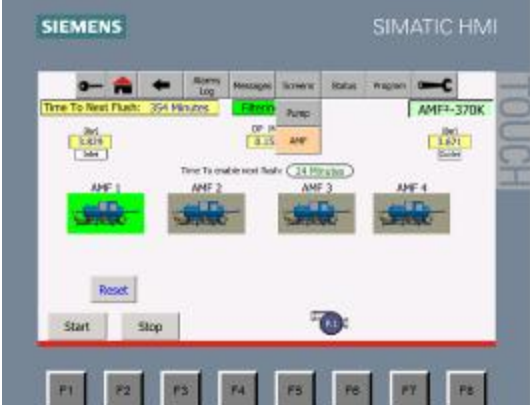
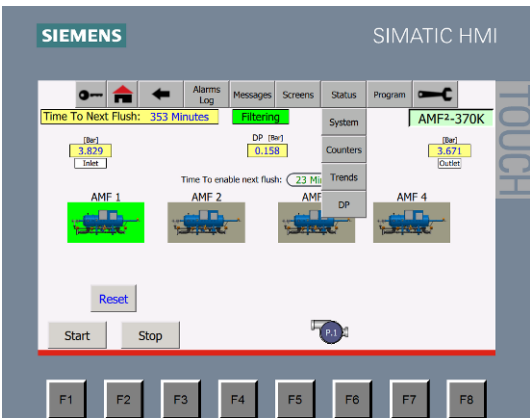
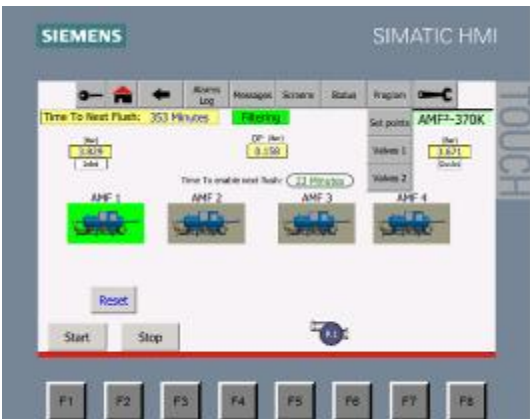
 <p>The screenshot shows the 'Screens' menu in the SIMATIC HMI. The menu is open, displaying options for 'Pump' and 'AMF-370K'. The 'Pump' option is highlighted in green. The background shows a control panel with various indicators and buttons like 'Start', 'Stop', and 'Reset'.</p>	<p>The General Section screens - Screens list menu</p> <p>This screen shows the opened "screens menu list" of the system's general section.</p> <p>The options are:</p> <ul style="list-style-type: none"> • Pump screen • AMF screens
 <p>The screenshot shows the 'Status' menu in the SIMATIC HMI. The menu is open, displaying options for 'System', 'Counters', 'Trends', and 'DP'. The 'System' option is highlighted in green. The background shows the same control panel as the previous screenshot.</p>	<p>The General Section screens - Status menu</p> <p>This screen shows the opened "status menu list" of the system's general section.</p> <p>The options are:</p> <ul style="list-style-type: none"> • System Status screen • Counters screen • Trends Screen • DP screen
 <p>The screenshot shows the 'Program' menu in the SIMATIC HMI. The menu is open, displaying options for 'Set points', 'Valves 1', and 'Valves 2'. The 'Set points' option is highlighted in green. The background shows the same control panel as the previous screenshots.</p>	<p>The General Section screens - Program menu</p> <p>This screen shows the opened "Program menu list" of the system's general section.</p> <p>The options are:</p> <ul style="list-style-type: none"> • Set points screen • Valves 1 screen • Valves 2 Screen

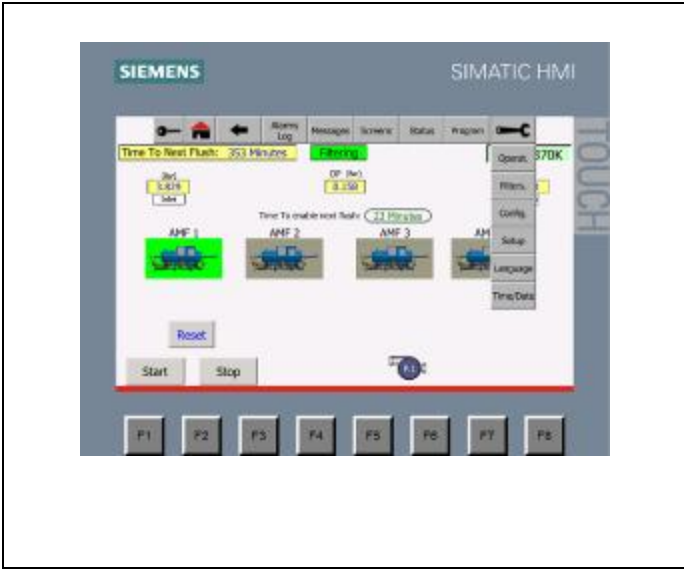

The General Section screens - Tools menu

This screen shows the opened "Tools menu list" of the system's general section.

The options are:

- Operations screen
- Filters screen
- Configuration screen
- Setup screen
- Language select screen
- Time/Date screen

The Menu List Screens - Screens

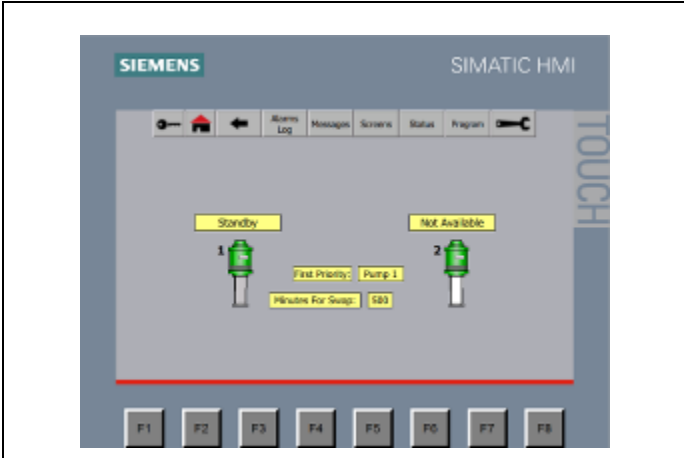

Pump Screen

This screen presents the two pumps with the current status of each pump:

First Priority - the number of the current On Duty pump.

Minutes for swap - the time left until the Stand-by pump will replace the On Duty pump.

The System Status Screens

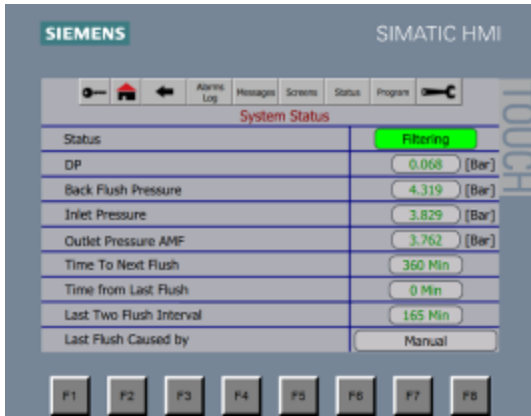

System Status Screen

This screen presents the System Status Table:

Status – The general status of the system: Idle, Pause, Filtering, Back-flushing, Fault, Attention, Alarm, Delay, etc.

DP - The current Differential Pressure reading

Back Flush Pressure - the current reading of the flush line pressure.

Inlet Pressure - The current Inlet Pressure reading

Outlet Pressure - The current Outlet Pressure reading

Time to next Flush - Time to the next timed flush cycle. It reset back to the initial value with every flush cycle.

Time from last flush - The time passed from the previous flush.

Last Two Flush Interval - the time passed between the two previous flush cycles.

Last flush caused by - The trigger that started the previous flush cycle.

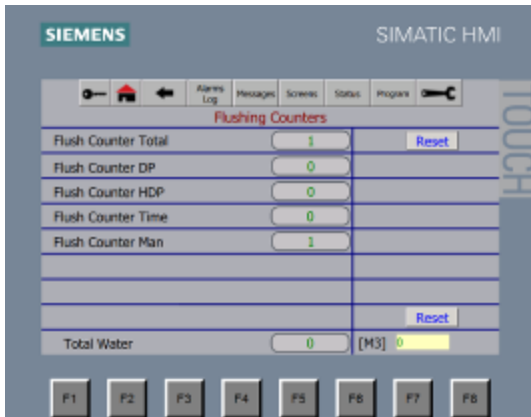

Counters Screen

This screen presents:

Flush Counter – The total number of flush cycles performed since the last reset of the counter. Press the Reset button to reset the counter to zero.

Flush counter DP - the number of flush cycles performed due to a DP signal.

Flush counter HDP - the number of flush cycles performed due to a High DP signal.

Flush counter Time - the number of flush cycles performed due to the interval time timer.

Flush counter Man - the number of flush cycles performed due to a Manual start command.

Total Water - the water accumulation - the volume of water that passed through the system since the last reset of the counter. Press the Reset button to reset the counter to zero.

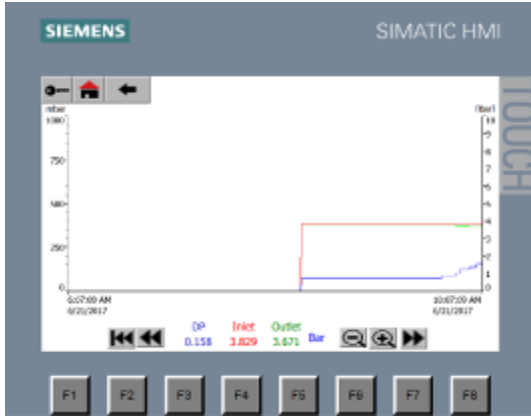

Trends Screen

This screen presents 3 optional trends:

The DP trend (The blue line and the left Y axis)

The Inlet pressure (The red line and right Y axis)

The Outlet pressure (The green line and the right Y axis)

The Zoom Keys allow the user to set the span of the trends window.

Upon entering to this screen the trends span is 4 hours. Use the zoom keys to select between 0.5, 1, 2, 4, 8, 16 and 32 hours.

The right and left arrows move the trends window one screen to the left or to the right.

The left most arrow icon key returns the trends to the beginning point.

Since the left Y axis serves the Inlet and the Outlet Pressure Meters, the type of these two meters should be exactly the same.

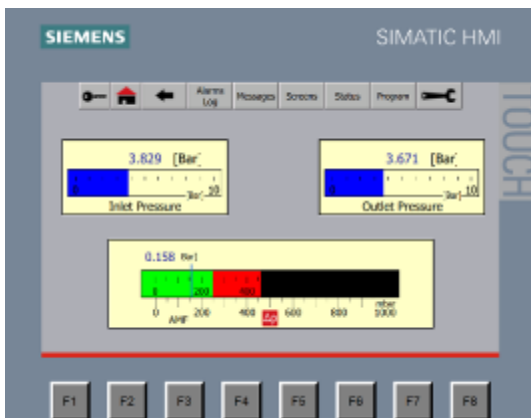

DP Screen

This screen presents:

The inlet pressure gauge at the upper right box

The outlet pressure gauge at the upper left box (if exists)

The DP gauge at the lower central box.

The border line between the green and red areas represents the DP set point for regular flushing.

The border line between the red and black areas represents the DP set point for High DP flushing.

The Program screens

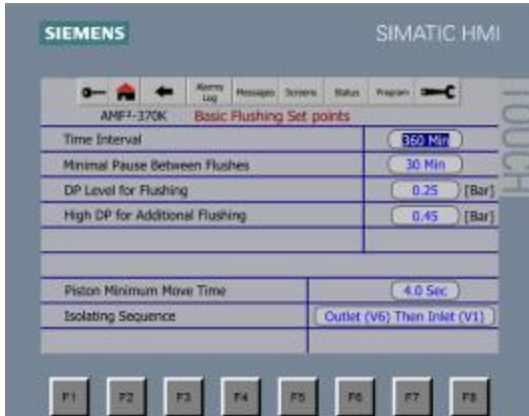

Basic Flushing Set points Screen

This screen allows the operator to set the:

Time interval - Set the maximum elapse time between flush cycles. It is recommended that flush cycle will take place at least once every 24 hours [1440 min.]. Enter 9999 for disabling this option.

Minimum Pause Between Flushes - Set the minimum elapse time between flush cycles. In case of a PD request for flushing within this time, the ALARM lamp turns On. Enter 9999 for disabling this option.

DP level for Flushing - Set the desired DP value to start flushing. Enter 9999 for disabling this option.

High DP for Additional Flushing - The desired HDP (High DP) value to start a flush cycle. Enter 9999 for disabling this option.

Piston Minimum Move Time - The minimal movement time of the filter's piston. In shorter movement time the filter enters to fault mode.

Isolating Sequence - the order of the isolation valves operation during flushing. The options are: Inlet (V1) Then Outlet (V6), Both.



Valves 1 Screen

This screen allows the operator to set the:

In Out Valve Difference - set the delay between the operation of the inlet and the outlet valves.

Inlet / Outlet Closing Delay – Set the delay for closing the inlet and outlet valves. (Default value - 10 seconds.)

Duration of Filter Draining – Set the time required to completely emptying the filter. (Default value - 60 seconds.)

Flush Valve Closing Delay – Set the delay for closing the Flush Valve (V5). (Default value - 10 seconds.)

Drain Valve Closing Delay – The delay for closing the Drain Valve (V4). (Default value - 10 seconds.)

Duration of Filter Refilling - Set the time required to fill the filter after flushing. (Listen to the noise of the exhaust air in order to determine the end of the filling process). (Default Value - 40 seconds.)

Inlet Valve Opening Delay – Set the delay for opening the inlet valve of the filter. (Default value - 10 seconds.)

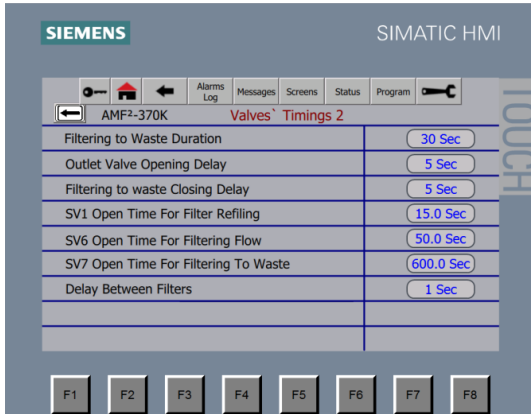

Valves 2 Screen

This screen allows the operator to set the:

Filtering to Waste Duration – Set the required time for the “filtering to waste” stage (V7). (Default value - 55 seconds.)

Outlet Valve Opening Delay – Set the delay for opening the outlet valve of the filter. (Default value - 10 seconds.)

Filtering to Waste Closing Delay – Set the required time for closing the “filtering to waste” Valve (V7). (Default value - 10 seconds.)

SV1 Open time for filter refilling - Set the time required for refilling the filter during the flushing cycle.

SV6 Open time for filtering Flow - Set the time required for opening the SV6 valve during the filtering mode.

SV7 Open time for filtering to waste - Set the time required for opening the SV7 valve during the filtering to waste mode.

Delay between Filters - Set the delay in seconds between the ends of the flush cycle of one unit to the start of the cycle of the next unit.

Press on the Programs menu to return to the set points list

The Tools screens

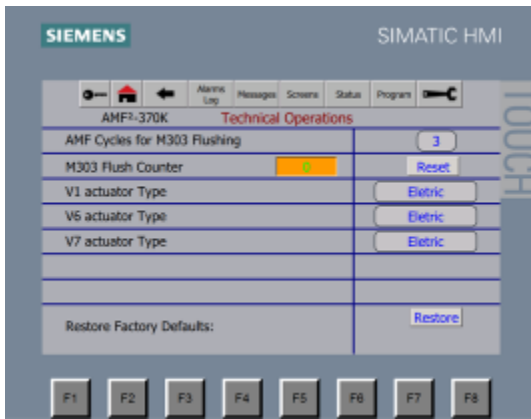

Operations Screen

This screen allows the operator to:

AMF Cycles for M303 Flushing – the number of AMF² filter flush cycles for flushing the M303 filter.

M303 Flush Counter - The flush counter of the M303 filter - Press the Reset button to reset this counter to zero.

V1 Actuator type - Select the type of this valve actuator (in this project it should be electrical).

V6 Actuator type - Select the type of this valve actuator (in this project it should be electrical).

V7 Actuator type - Select the type of this valve actuator (in this project it should be electrical).

Restore Factory Defaults - Use this option to reset the system's parameters to their factory defaults.

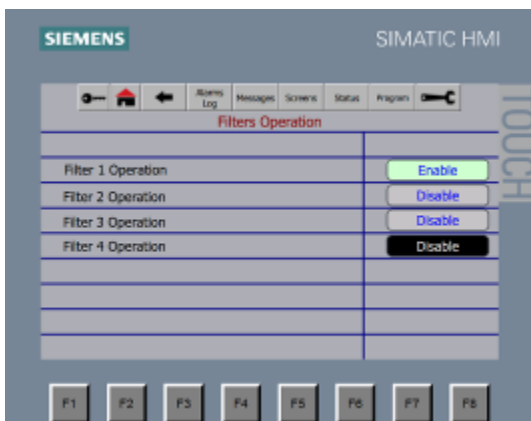

Operations Screen

This screen allows the operator to:

Filter 1 Operation – Enable / Disable the filter operation. Usually used in multi-filters installation or for maintenance works.

Filter 2 Operation – Enable / Disable the filter operation. Usually used in multi-filters installation or for maintenance works.

Filter 3 Operation – Enable / Disable the filter operation. Usually used in multi-filters installation or for maintenance works.

Filter 4 Operation – Enable / Disable the filter operation. Usually used in multi-filters installation or for maintenance works.

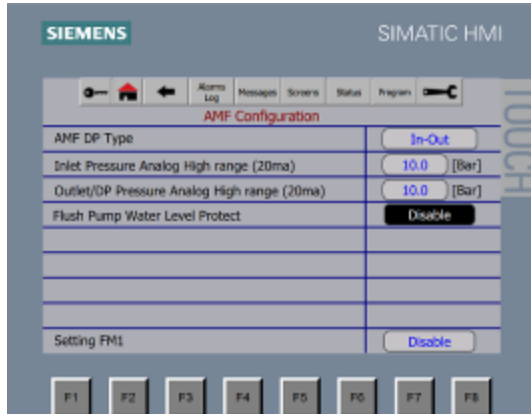

Configuration Screen

This screen allows the operator to set:

AMF DP Type – Set the type of the system's DP. The options are In-Out (calculated), Analog or Digital.

Inlet Pressure Analog High range (20ma) – This parameter sets the maximum range of the Inlet Pressure Meter. Since the meters are of 4-20 type, the software assumes that Pressure of 0 bar is equal to 4 milliamps. So the user has to enter only the maximum Pressure value for the 20 milliamp reading, i.e. 10 bar, 16 bar, etc.

Outlet/DP Pressure Analog High range (20ma) – This parameter sets the maximum range of the Outlet or the DP Meters. Since the meters are of 4-20 type, the software assumes that Pressure of 0 bar is equal to 4 milliamps. So the user has to enter only the maximum Pressure value for the 20 milliamp reading, i.e. 10 bar, 16 bar, etc.

If the user would like to flush the filter according to a differential Pressure it is necessary to install two pressure meters; Inlet and Outlet. In such case this parameter is used to set the maximum range of the Inlet and the Outlet Pressure Meters. The DP reading in this case is calculated by the software by subtracting the outlet pressure from the inlet pressure.

Flush Pump Water Level Protect – enable or disable the water level protection for the flush pump. When enabled the controller will not start the flushing cycle when there is not enough water for the flush pump.

Setting FM1 – Set the status of the FM1 (Flow meter 1), Disabled or Enabled.

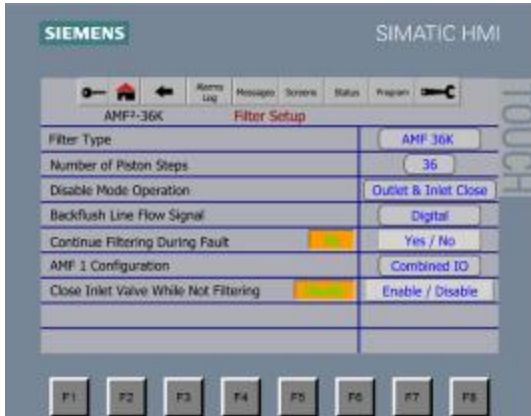

Filter Setup Screen

This screen allows the operator to set:

Filter Type – This field **must be AMF 370K**.

Number of Piston Steps – The user may set the number of piston strokes per flushing cycle. For normal operation of the filter this parameter **must be 36**.

Disable Mode Operation – Select the behavior type of the system when the filter is set to disabled mode. The options are: close the Inlet & Outlet valves or leave them opened.

Back-flush Line-flow Signal - Set the type of the no flow sensor of the flush line. The options are Digital or Analog.

Continue Filtering during fault - Select the system behavior during fault; stop filtering or continue.

AMF 1 Configuration - select the type of the system's control board. In this project this field **Must be Combined IO**.

Close Inlet Valve While not Filtering - Select the behavior of the Inlet valve while not filtering; close the valve or leave it opened.



Language setting Screen

This screen allows the operator to select the desired user interface language.

Please see the language selection chapter of this document 3.7 for details.

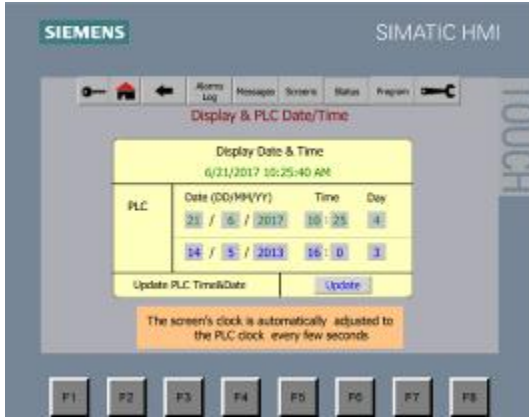

Time/Date Screen

This screen allows the operator to set the system time:

There are two clocks in the system: the PLC clock and the HMI clock. The PLC clock has a backup battery and therefore it remains accurate after a power failure.

The HMI clock is automatically adjusted to the PLC clock every few seconds.

This screen allows the user to set the PLC clock.

Enter the correct time and date and press the UPDATE button to update the PLC clock.

3.8.2.2 Graphical screens - Filter

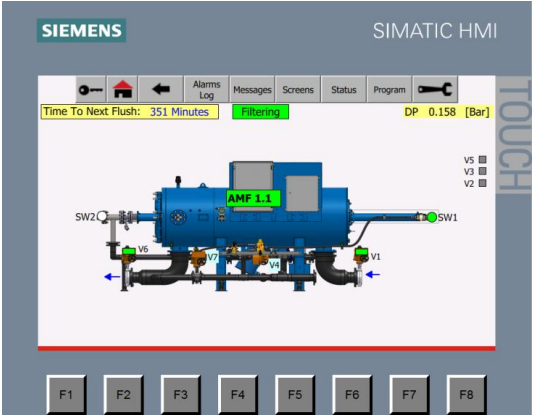
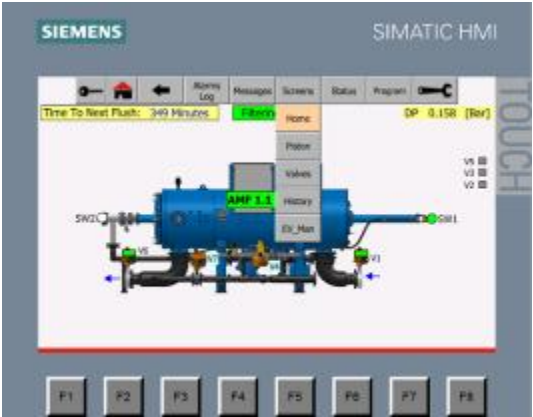
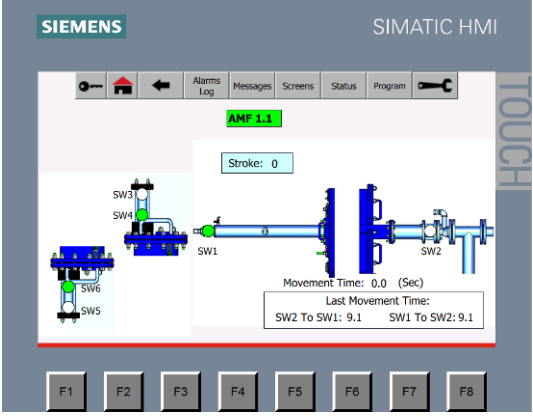
	<p>Main Screen - Front - Enter to this screen from the system's Home Screen</p> <p>This screen presents:</p> <ul style="list-style-type: none"> The status of the filter – in the upper middle box. The current DP reading – in the upper right yellow box The time to next flush - in the upper left yellow box The status of valves V2, V3 and V5 <p>The filter drawing shows the status of the various elements of the filter such as valves, piston, etc.</p> <p>Press any filter element to zoom-in to the specific detailed screen.</p> <p>Press any yellow box to display the detailed relevant screen.</p>
	<p>The Filter's screens menu</p> <p>This screen shows the opened "screens menu list" of the filter.</p> <p>The options are:</p> <ul style="list-style-type: none"> • Home • Piston • Valves • History • EV_Manual
	<p>Piston and Index Screen</p> <p>The piston</p> <p>This screen presents:</p> <p>A detailed piston drawing that shows the following:</p> <ul style="list-style-type: none"> SW1 & WS2 status (green or white according to the actual position of the piston) <p>The movement of the piston during flushing together with the stroke number and time.</p> <p>Attention messages (when applicable) at the area under the piston drawing.</p> <p>Alarm and Fault messages (when applicable) at the area above the piston drawing.</p> <p>Alarm and Fault status (appear on the piston in red)</p>

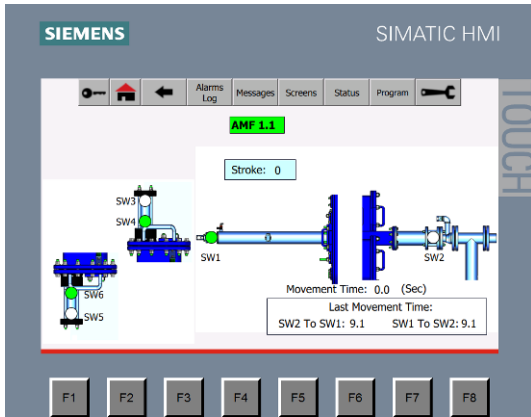

The Index

This screen presents:

A detailed drawing of the two index units that shows the following:

SW3 & WS4 status (green or white according to the actual position of the index)

SW5 & WS6 status (green or white according to the actual position of the index)

The movement of the index during flushing together with the stroke number.

Attention, Alarm and Fault messages (when applicable)

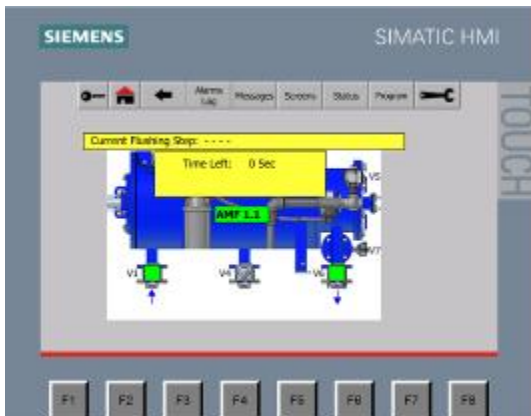

Valves Screen

This screen presents:

A detailed valves drawing that shows the following:

Text boxes:

The current flushing step (during flushing).

The labels of the operating valves.

The time left till the end of the current flushing step.

Graphical elements:

The status of the valves together with a direction arrow (green = operated black= not operated)

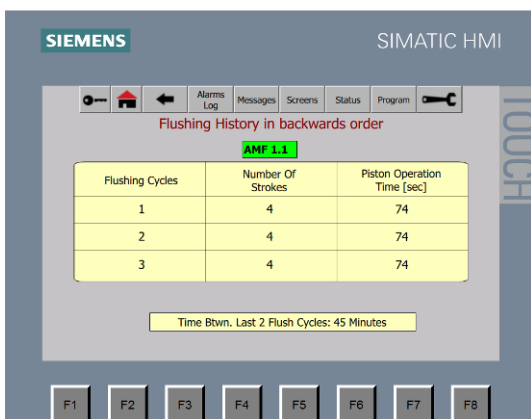

Flushing History Screen

This screen presents the flushing history in backwards order:

The table present the last 3 flush cycles.

For each cycle the table presents the Number of strokes of the piston, and the piston operation time in seconds.

The lower line presents the time between the last two flush cycles.

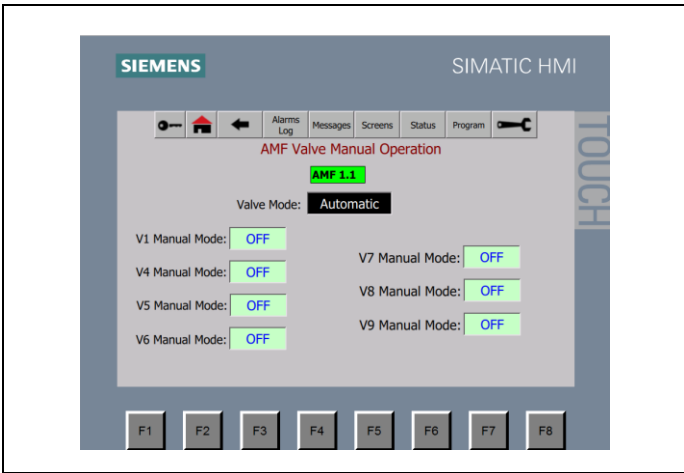

AMF Valves Manual Operation Screen

Valve Mode: - Select the desired operation mode. The options are: Automatic or Manual.

The screen presents the 7 valves of the filter. In manual operation mode each valve can be set to OFF, OPEN or CLOSE position.

A green circle near the valve shows its current operation mode.

3.8.3 The Filter Alarms Log screen

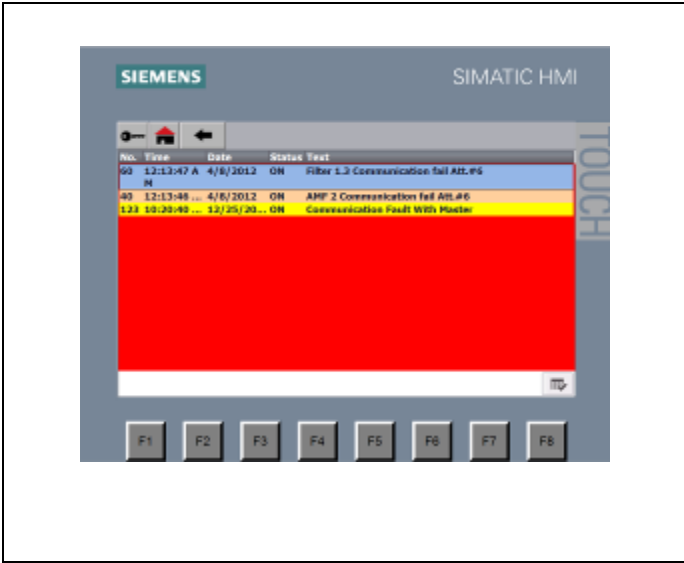

Alarms Log Screen

This screen presents the Alarms and Faults log:

Each line contains the number, the time, the date and the status of the message.

The messages are color coded according to their type.

The messages are stored in a cyclic buffer and it is not possible to delete the messages.

The buffer size depends on the HMI and the PLC versions.

The list of possible messages is found in Annex A.

3.8.4 System Messages Screen

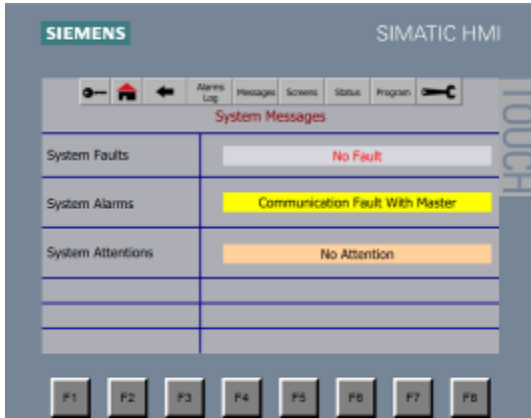

System Messages Screen

This screen presents:

System Faults – When the system has no faults "No Fault" is displayed. In case of more than one fault message, the display alternates the existing fault messages once at every 3 seconds.

System Alarms – When the system has no alarms "No Alarm" is displayed. In case of more than one alarm message the display alternates the existing alarm messages once at every 3 seconds.

System Attentions – When the system has no Attentions "No Attention" is displayed. In case of more than one message the display alternates the existing Attention messages once at every 3 seconds.

A list of possible system messages appears in chapter 3.9 of this manual.

3.9. List of system messages

This chapter lists the system messages divided into their categories:

The following table lists and describes the possible system alarms and attentions messages that may appear on the HMI status screens.

Alarm	Attention	ID	Message Text	Remarks
√		0	No Alarm	
	√	0	No Attention	
√		1	Pump 1 Fault #1	Back-flush pump 1 soft starter fault
	√	2	No Pump Available #2	All the pumps in the system are disabled or in fault mode.
√		3	High DP #3	A flushing cycle triggered by a High DP signal.
√		5	Too Short Time From Last Flushing #5	A requirement for starting a flushing cycle is present while the "Minimum from Last Flush fault" is still counted. (Note: a flushing cycle triggered by the High DP parameter is not affected by this parameter.)
√		6	HDP Alarm #6	The High DP signal is still present after two consecutive flush cycles.
√		7	Low Inlet Pressure #7	The Inlet Pressure is lower than the minimum required for starting a flushing cycle.
√		8	Cycle Stopped #8	A Manual stop of the flush cycle was done
√		9	No Water for Back-flush #9	The flushing water tank is lower than the minimum required for starting a flushing cycle.
√		17	Filter 1 Communication Fault #17	Communication fault between the master controller and filter 1 control board
√		25	No Response Filter 1 #25	No acknowledge from filter 1 to "start flushing" command issued by the master controller
√		33	Filter 1 SW1 & SW2 Both Closed #33	A contradictory faulty indication on the main piston location (probably due to a short circuit).
√		34	Filter 1 SW3 & SW4 Both Closed #34	A contradictory faulty indication on the Index piston location (probably due to a short circuit).
√		36	Filter 1 SW4 Not Found at Startup #36	The Index piston is not locked so the main piston is not allowed to move.
√		37	Filter 1 Piston Movement SW1 to SW2 #37	The main piston started to move from SW1 to SW2 but the movement is not completed. This fault message is issued only after an unsuccessful second trial to push the piston by the controller. In a multi filters installation this is a fault status of the specific filter, since the other filters are still operational the system issues only an alarm message.
√		38	Filter 1 Index Fault #38	The Index piston is not locked. This fault message is issued only after a second trial to push the piston by the controller.
√		39	Filter 1 Index Fault SW4 #39	The emptying process of the filter is completed but the index piston is not locked. (Index SW4)
√		41	Filter 1 Emergency Stop #41	The Stop Button of the filter was pressed during a back-flush cycle.

	v	42	Filter 1 Piston SW1 to SW2 Att. #42	The main piston started to move from SW2 to SW1 but the movement is not completed. This is a system alarm message that is issued during the second trial to push the piston by the filter's controller.
	v	43	Filter 1 Piston SW2 to SW1 Att. #43	The main piston started to move from SW2 to SW1 but the movement is not completed. This is a system alarm message that is issued during the second trial to push the piston by the filter's controller.
	v	44	Filter 1 Index Backward Alarm #44	The Index piston is not unlocked after a forward command. The controller performs a second trial to push the piston and during this trial this alarm message is displayed.
	v	45	Filter 1 Index Forward Att. #45	The Index piston is not locked after a backward command. The controller performs a second trial to push the piston and during this trial this alarm message is displayed.
v		46	Filter 1 Piston Movement SW2 to SW1 #46	The main piston started to move from SW2 to SW1 but the movement is not completed. This fault message is issued only after an unsuccessful second trial to push the piston by the controller. This is a fault status of the specific filter, since the other filter is still operational the system issues only an alarm message.

The following table lists and describes the possible system fault messages that may appear on the controller's status screens.

ID #	Message Text	Remarks
0	No Fault	
1	System Fault #1	All the AMF ² filters in the system are disabled or in fault mode.
2	No Pump Available #2	The back-flush pumps are in fault mode or in OFF position
4	Low Inlet Pressure #4	The Inlet Pressure is lower than the minimum required for starting a flushing cycle.
5	HDP Fault #5	The differential pressure across the AMF ² filters exceeds the HDP preset value

4. Start-up and First Operation

In order to achieve maximum performance and smooth operation of the filter it is crucial to perform the Startup and First Operation procedures exactly as described in this section. Please read carefully the following instructions prior to any attempt to operate the filter.

- **Commissioning the filter should be done by an authorized Amiad technician, do not attempt to commission the filter unaccompanied.**
- **Please contact your supplier for coordinating a technician visit.**
- **Failing to coordinate the start-up process with your supplier may lead to undesired damage and may affect your warranty coverage.**

The start-up procedure is a multistage process; the following checklists describe step by step the actions to be done in order to successfully commission the filter:

4.1. Dry stage – connections verification

Important notes:

Before starting the dry stage of the filter start-up it is very important to make sure that the filter is empty and isolated from the water system by verifying visually that:

- **The upstream and the downstream manual isolation valves are closed**
- **The flushing water supply line isolation valve is manually closed**

Consult your Certified Installation Arrangement Drawings for these manual valves details.

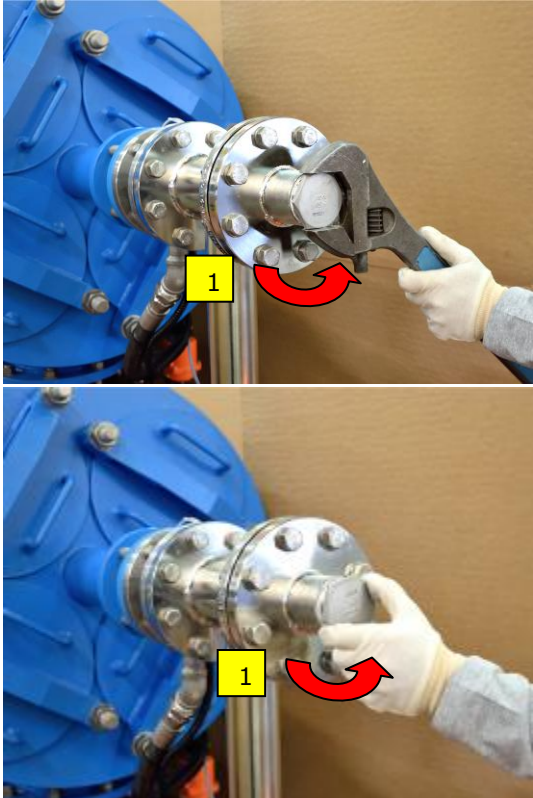

The following checklist lists the actions to be done during the dry stage.

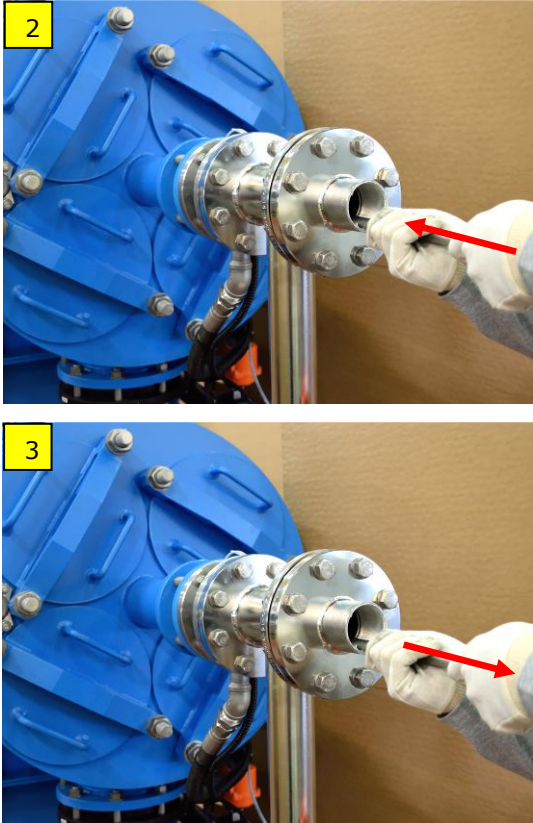
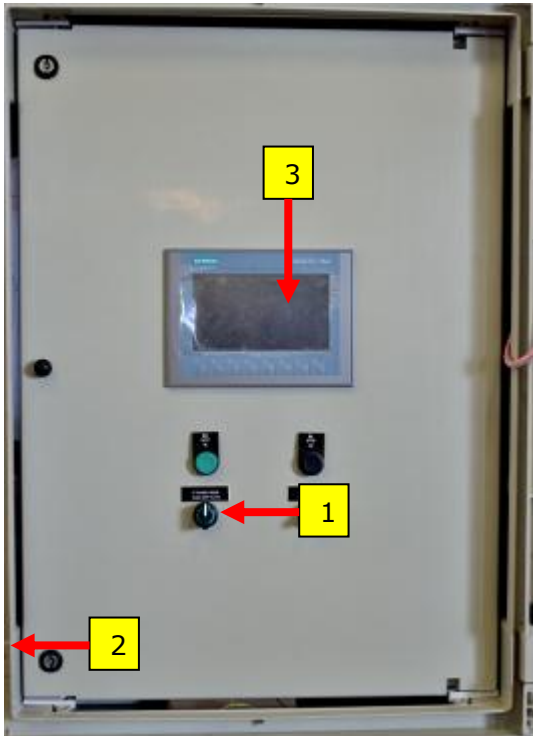
√	Num.	Action	Picture
	4.1.1	<p>Main piston positioning: In order to ensure that the main piston's spray nozzles are not within the cassette package limits, it is necessary to verify that the main piston is at SW1 switch position.</p> <ol style="list-style-type: none"> 1. Remove the plug from the 3" flange of the tail assembly. 2. Insert a clean and straight 4.5 meter 0.5" pipe or rod through the opened connection. 3. Using the rod push the piston all the way in and then remove the rod out of the filter. 	

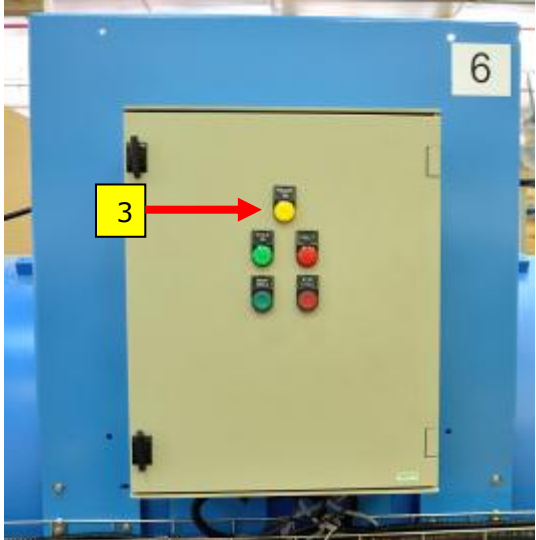
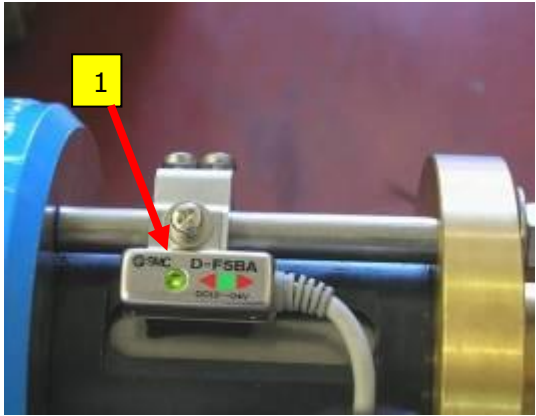
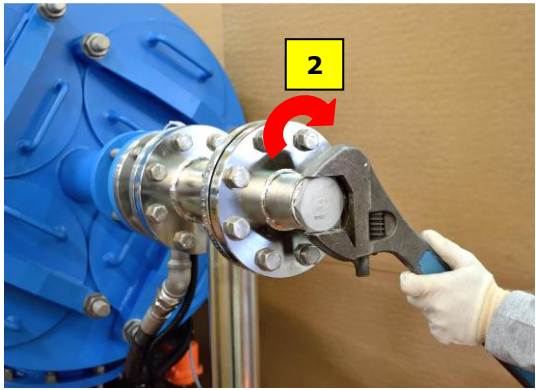
			
4.1.2		<ol style="list-style-type: none"> 1. Make sure that the flushing pump SELECTOR SWITCH at the master control board is in off position. 2. Switch on the power at the master and slave control boards by turning on the MAIN POWER SWITCHS. 3. Make sure that the POWER ON LAMP and the controller's PANEL are lighted up. 	

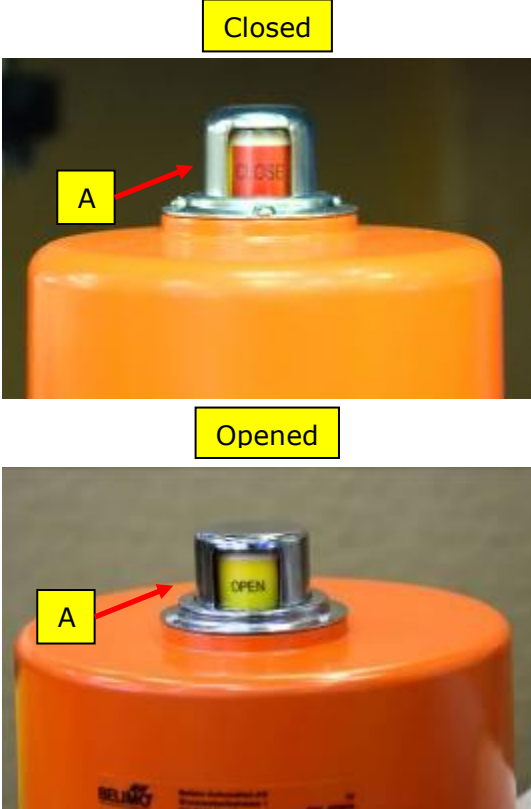
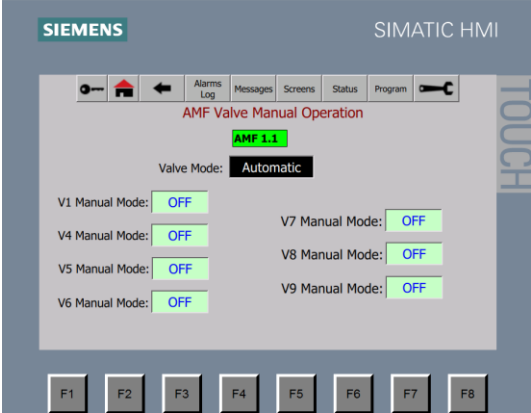
		 <p>A photograph of a blue control panel with a white door. The door has a yellow light at the top, a green light in the middle, and a red light at the bottom. A red arrow points from a yellow box with the number '3' to the yellow light. The number '6' is visible in the top right corner of the panel.</p>
<p>4.1.3</p>	<ol style="list-style-type: none"> 1. Verify that magnetic switch SW1 led is on. This indicates that the main piston is in the right position. 2. Return the plug to its place on the 3" flange and tighten it firmly. <p>If SW1 led is not ON do not proceed and contact your supplier immediately!!!</p>	  <p>Two photographs illustrating the steps. The top photo shows a magnetic switch labeled 'Q-9AC D-F5BA' with a green LED lit. A red arrow points from a yellow box with the number '1' to the LED. The bottom photo shows a person using a wrench to tighten a plug on a blue flange. A red arrow points from a yellow box with the number '2' to the plug.</p>

<p>4.1.4</p>	<p>Valves connection verification: This stage ensures that each one of the filter's valves is connected correctly to the filter's control system.</p> <p>Note: The filter's valves are double action electrical valves. Their opening status is indicated by a position indicator which displays the words OPEN or CLOSED according to the actual valve status. (See pictures A, B for reference).</p> <p>A. Visually check that all the filter's valves are connected to their control and power cables. B. Connect the valves to the power supply. C. Make sure that the manual override handles of all the panel relays are at their Automatic position. D. Check the position indicator of each one of the filter's valves and verify that it is pointing to the correct position according to the following list:</p> <ul style="list-style-type: none"> • Inlet Valve – Opened • Outlet Valve – Opened • Drain Valve – Closed • Flushing Valve – Closed • Filter to Waste Valve – Closed <p>Note: In the rare case where one of the valves is found indicating to the wrong direction, ask your electrician to check and correct the connections of this valve.</p>	
<p>4.1.5</p>	<p>Valves operation verification: This stage ensures that each one of the filter's valves functions correctly.</p> <p>Note: This stage requires two persons to complete, a technician at the sub master control cabinet and an assistant near the valves.</p> <p>1. Use the HMI's Manual operations screen of the sub-master control board to check the valves operation. Press each one of the valves Icon to force the valve to change position (From Open to Closed or vise versa). Release the Icon to let the valve return to its original status. Check each one of the valves and make sure that the responding valve is the correct valve as indicated in the following list. Make sure that the valve changes its position during the manual override and returns back to its original position once the icon is released.</p> <ul style="list-style-type: none"> • Inlet Valve – EV1 • Outlet Valve – EV6 • Drain Valve – EV4 • Flushing Valve – EV5 • Auxiliary Flushing Valve – EV5 • Filter to Waste – EV7 <p>In case that valve connections mismatch is found ask you electrician to change the connections between the valves. In such case after the connections change stages 3.1.4 and 3.1.5 should be performed again.</p>	

4.1.6	<p>Flushing Pump rotational direction check: This stage ensures that the flushing pump rotates in the correct direction.</p> <p>Note: This stage requires two persons to complete, a technician at the master control cabinet and an assistant near the pump.</p> <ol style="list-style-type: none">1. Turn the flushing pump MANUAL/OFF/AUTO selector switch for one second only to MANUAL position and immediately turn it back to OFF position.2. Check the pump's rotation direction and make sure that it matches the direction of the arrow on the pump motor cover. If the pump rotates in the wrong direction ask a qualified electrician to correct the direction by changing the connection of two of the phases in the electrical board terminal.	<p>These pictures are for demonstrating the required process only.</p>  
-------	---	--

4.2. Wet stage A. – Initial flushing cycle

Important notes:

During this stage of the filter’s start-up the filter remains isolated from the process water. The supply line for the following procedures is the flushing water supply line which is the source of clean water used for the filter’s cleaning cycles.

Before starting wet stage A. it is very important to make sure that the filter remains isolated from the Process Water System by verifying visually that the upstream and the downstream manual isolation valves are closed. Consult your Certified Installation Arrangement Drawings for these manual valves details.

The following checklist lists the actions and the order of the tasks to be done during wet stage A.

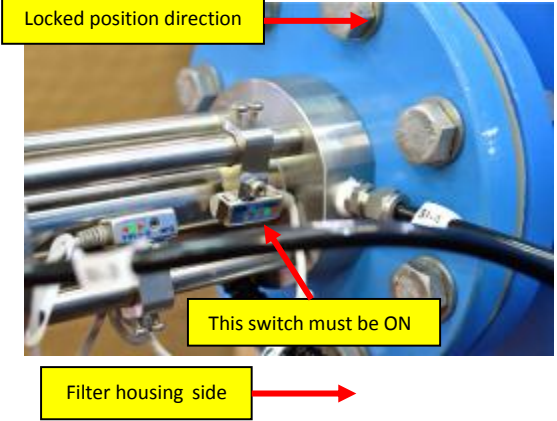
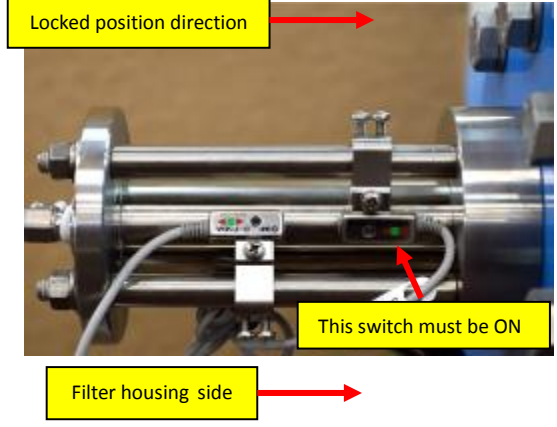
√	Num.	Action	Picture
	4.2.1	Connecting the filter to the flushing water source: <ol style="list-style-type: none"> 1. Open the Manual Isolation Valve of the clean flushing water supply line and check the filter for leaks. 2. Make sure that air was released from the back-flushing pumps. 	
	4.2.2	Index pistons positioning: Ensure that the cassette packages are aligned with the spray nozzles and that the index pistons are in their locked position: <ol style="list-style-type: none"> 1. Check that the SW4 index piston is at SW4 switch position by verifying that the led of switch SW4 is lighted on. This indicates that the piston is locked at the “near to the filter housing” side of the index cylinder. 2. Perform the same check for the SW6 index piston and verify that the led of switch SW6 is lighted on. <p>If one of the index-pistons (or both) is not locked at the right position, switch on manually the flushing pump for no more than 2 seconds and then recheck the magnetic switches. You may perform this action only once! If any of the index pistons fails to reach its locked position stop the filter start-up process and contact your supplier.</p> <p>If SW4 & SW6 leds are not ON do not proceed and contact your supplier!!!</p>	 

3. **4-Way control unit** – the Index Pistons are controlled by a 4 way control unit installed near the SW4 index piston.

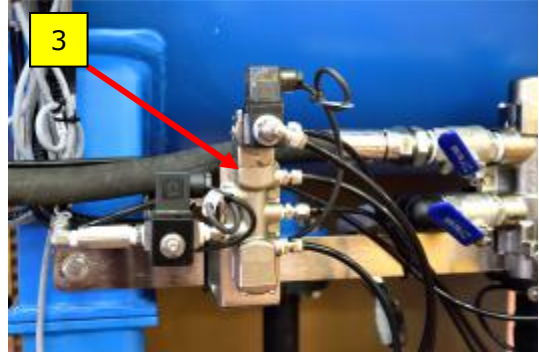

4.2.3

Start a manual back-flush cycle through the sub-master control board and run through the process from start to end.

1. Monitor the progress of the back-flushing steps closely and verify that each step starts and stops correctly.
2. Make sure that the discharge pressure of the flushing pump is 10 bars. If the pressure does not meet this level do not continue the flushing and check the pump for malfunctions such as: wrong rotation direction, insufficient air bleeding, insufficient water supply, etc.
3. During the Cartridges' Cleaning steps use the 2 adjustment ball valves located at the controlled manifold to set the main piston movement speed to 9-10 seconds in each direction.
4. The upper valve controls the piston movement from SW1 to SW2.
5. The lower valve controls the piston movement from SW2 to SW1.

If any malfunction is encountered during this process stop the operation and contact your supplier!

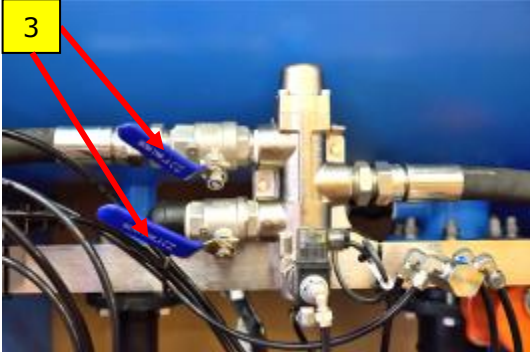

4.3. Wet stage B. – First filtration cycle

Important notes:

In this stage the filter’s starts the actual filtration of the process water.

The following checklist lists the actions and the order of the tasks to be done during wet stage B.

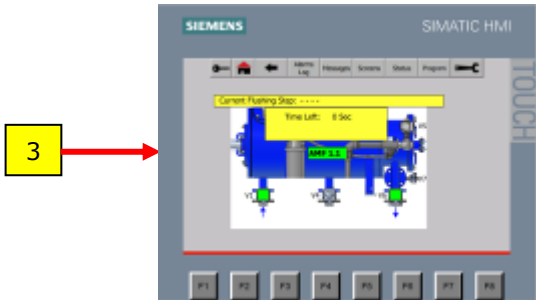
V	Num.	Action	Picture
	4.3.1	<p>Connecting the filter to the process water system:</p> <ol style="list-style-type: none"> 1. Open gradually and slowly the Inlet Manual Isolation Valve (the upstream valve) and let the unfiltered process water to enter the filter. Consult your Certified Installation Arrangement Drawings for this manual valve details. 2. During the filling process of the filter check the air release valve and make sure that air is released from the filter. 3. Open gradually and slowly the Outlet Manual Isolation Valve (the downstream valve). The filter starts to filter the process water. 4. Check the filter for general leakages and fix any leak found. 	
	4.3.2	<p>First complete flushing process:</p> <ol style="list-style-type: none"> 1. Let the filter work and filter the process water for about an hour. 2. Initiate a flushing cycle by pressing the START CYCLE push button on the control cabinet door. 3. Monitor the emptying process of the filter during the Flushing Initiation Steps and verify that by the time the high pressure flushing valve is opened the filter housing is already empty. If the time setting is too short for completely emptying the filter increase the number at the Open Drain Time parameter. 4. Note: - it is possible to set a longer time than the 120 seconds default value but it is not allowed to shorten the factory default. 	 

Once the wet stage B. procedure is correctly completed the filter is up and running.

5. Technical Specifications

5.1. Standard AMF 370K-S Specifications

Technical Specifications:	
Filtration Degree	2,3,7,10, micron
Flange connections	8" Inlet/Outlet, 1x4" Drains, 1x2" Drain, 1x3" Drain PN10 and 1x2.5" Flush PN16
Flow Rate	Recommended 80 –200 m3/h dependent on water quality, application, filtration degree, etc
Minimum Working Pressure	Gravity Flow 0.5 Bar
Maximum Working Pressure	10 barg
Design Pressure	10 barg
Maximum Working Temperature	40-degree C
Filtration Area	370000 cm2
Filtration Element	3640 Cassette Units
Inlet/ Outlet Valves	8" Electric 24V/DC Actuated Butterfly Valve
Drain Valve	4" Electric 24V/DC Actuated Butterfly Valve
Outlet Drain Valve	3" Electric 24V/DC Actuated Butterfly Valve
Drain Valve	2" Manually Operated Butterfly Valve
Flush Valve	2.5" Electric 24V/DC Actuated Butterfly Valve
Nozzle Protection Filter	200-micron filter
Flush Pump Flow Characteristics	20 m3/h
Flush Pump Discharge Pressure	~ 9 barg
Flush Pump Power Requirements	Maximum 11 Kw (suction pressure dependant)
Flush Sequence Time	Approximately 10 minutes
Flush Valve Open Time	6 – 7 minutes
Flush Water Quantity per Flush	3 - 5 m3/flush cycle
Weight Empty	2150 kgs including all accessories
Weight Full of Water	3350 kgs including all accessories

Installation Requirements:	
Sub Master Electrical Supply 25A	3 phase 400 volts/ 50 Hz
Pump Electrical Supply 11 Kw	3 phase-400 volts/ 50 Hz
Slave Control Electrical Supply	1 phase 24V/DC
Drainage Facilities	Gravity Flow 20m ³ /cycle of 36 counts (160mm)
Construction Materials:	
Filter Housing and Covers	Epoxy coated carbon steel
Cassette	Polyester thread on plastic body
Cassette Package	PVC, St/St, PTFE, Cassettes
Pistons: Index, 50mm, 40mm, etc	Brass, Bronze, St/St, HMWPE
Seals	Nitrile Rubber (NBR) in general
Pressure Hoses	Rubber
Bolts, Nuts, Washers	External Galvanized, Internal St/St
Butterfly Valves	Cast Iron, EPDM, Brass, St/St
Ball Valve	St/St, PTFE
Controller	Siemens PLC and Operator Terminal
Control Tubing	Polyethylene
Installation Requirements:	

5.2. Control cabinet drawings

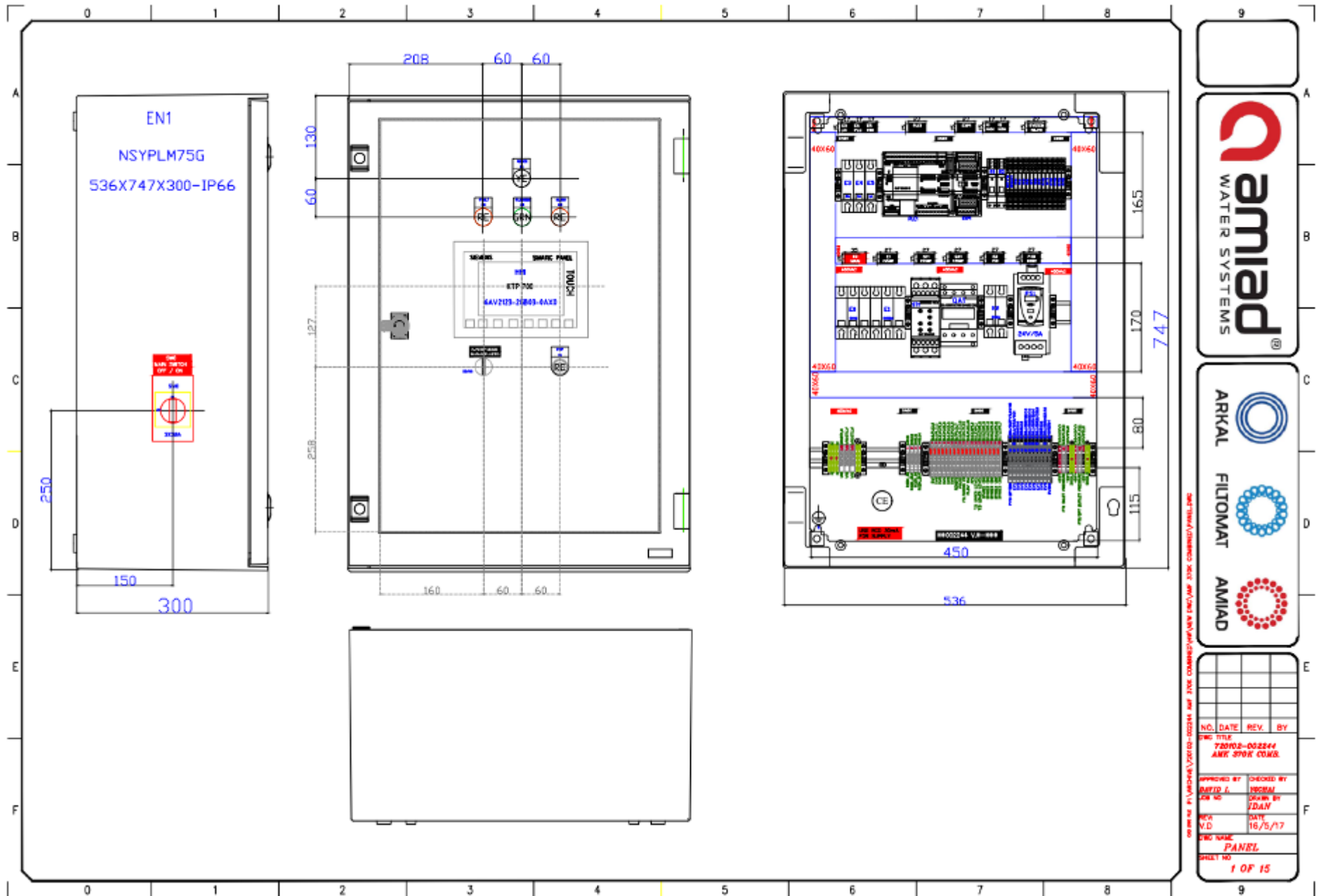









NO.	DATE	REV.	BY
72003-02244			
AMK 370K COMB.			

APPROVED BY:	CHECKED BY:
DESIGNED BY:	DESIGNED BY:
REV. V.D.	DATE:
	16/5/17

ENC NAME: PANEL
SHEET NO.: 1 OF 15

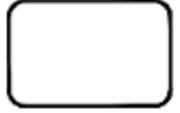
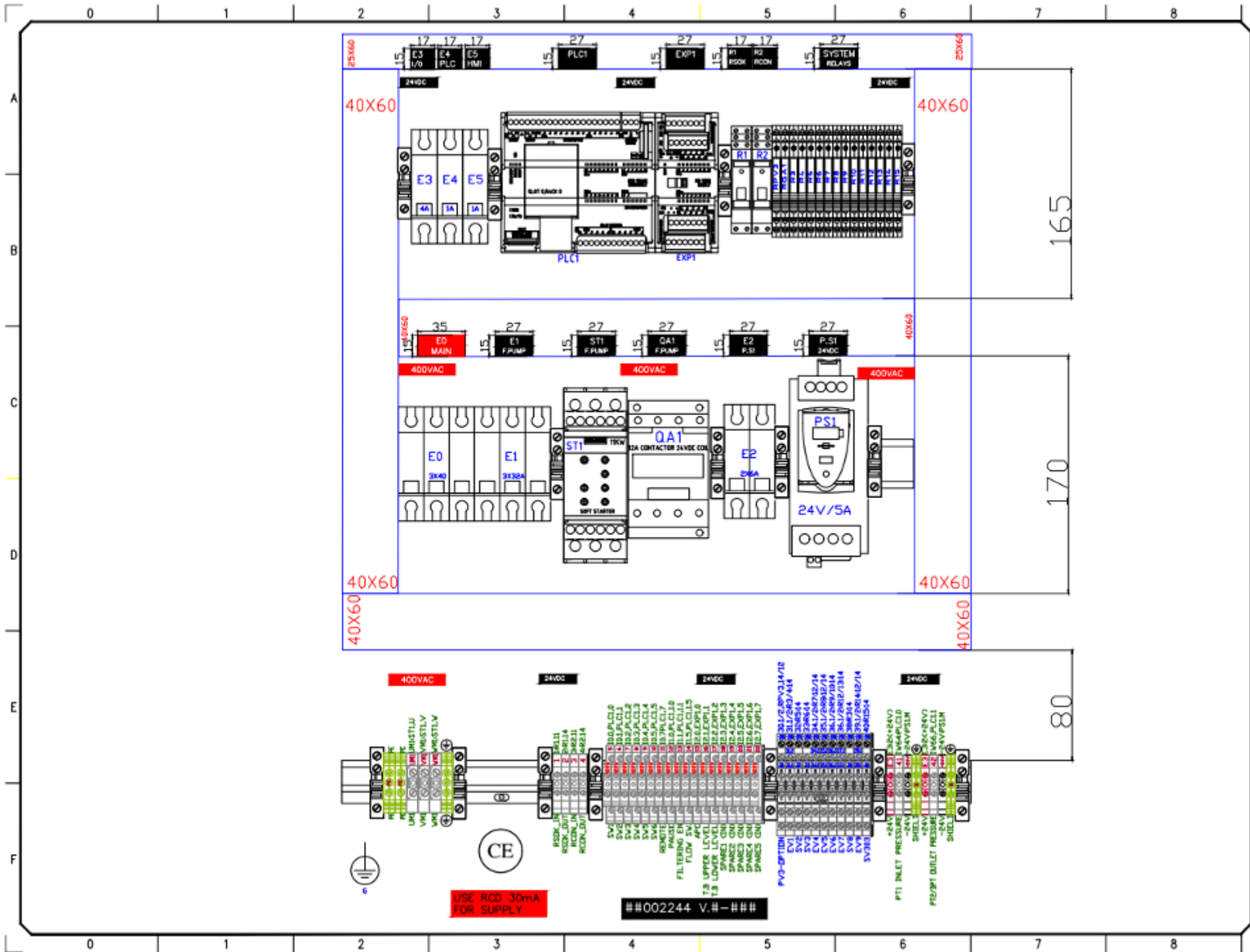

NO.	DATE	REV.	BY
Dwg TITLE			
720VDS-002244			
AMK 370K COMB.			
APPROVED BY	CHECKED BY		
DAVID J.	TUCKER		
DRAWN BY			
J.DAN			
REV. V.D.	DATE		
	16/5/17		
Dwg NAME			
LAYOUT			
SHEET NO			
2 OF 15			

*EXTERNAL
DOOR*

*INTERNAL
DOOR*

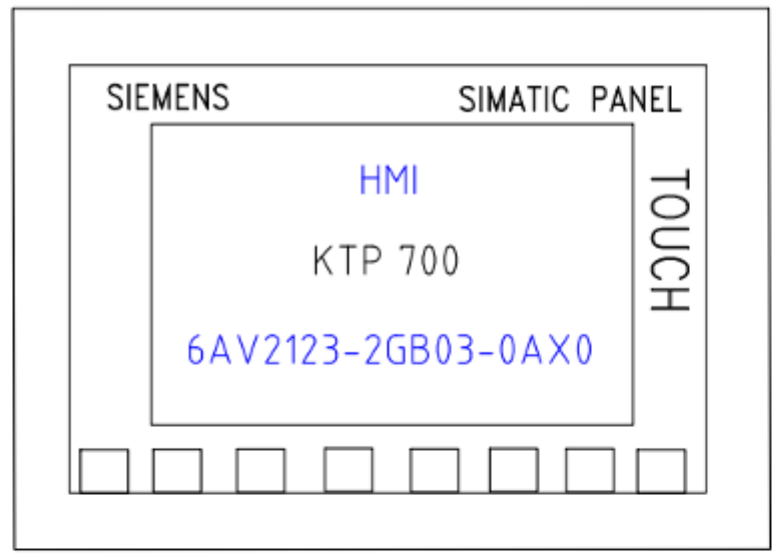
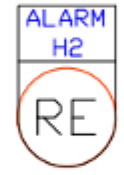
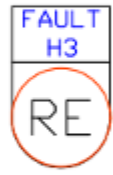
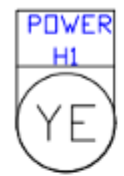

F. PUMP MODE
MAN-OFF-AUTO

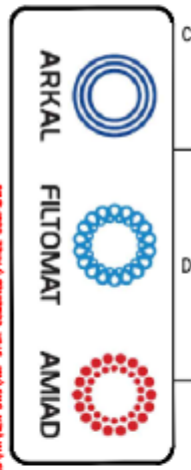
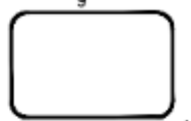
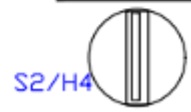

C:\Users\David.L\Documents\AMF 370K COMBINED PANEL COMP.DWG

NO.	DATE	REV.	BY
DWS TITLE			
720102-002244			
AMF 370K COMB.			
APPROVED BY		CHECKED BY	
DAVID L.		YOCWAI	
JOB NO		DRAWN BY	
		JDAN	
REV	DATE		
V.D	16/5/17		
DWS NAME			
PANEL COMP.			
SHEET NO			
3 OF 15			

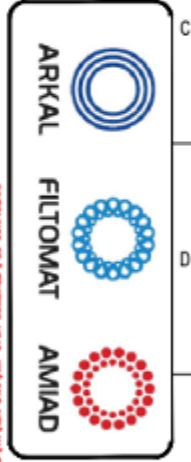
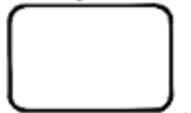
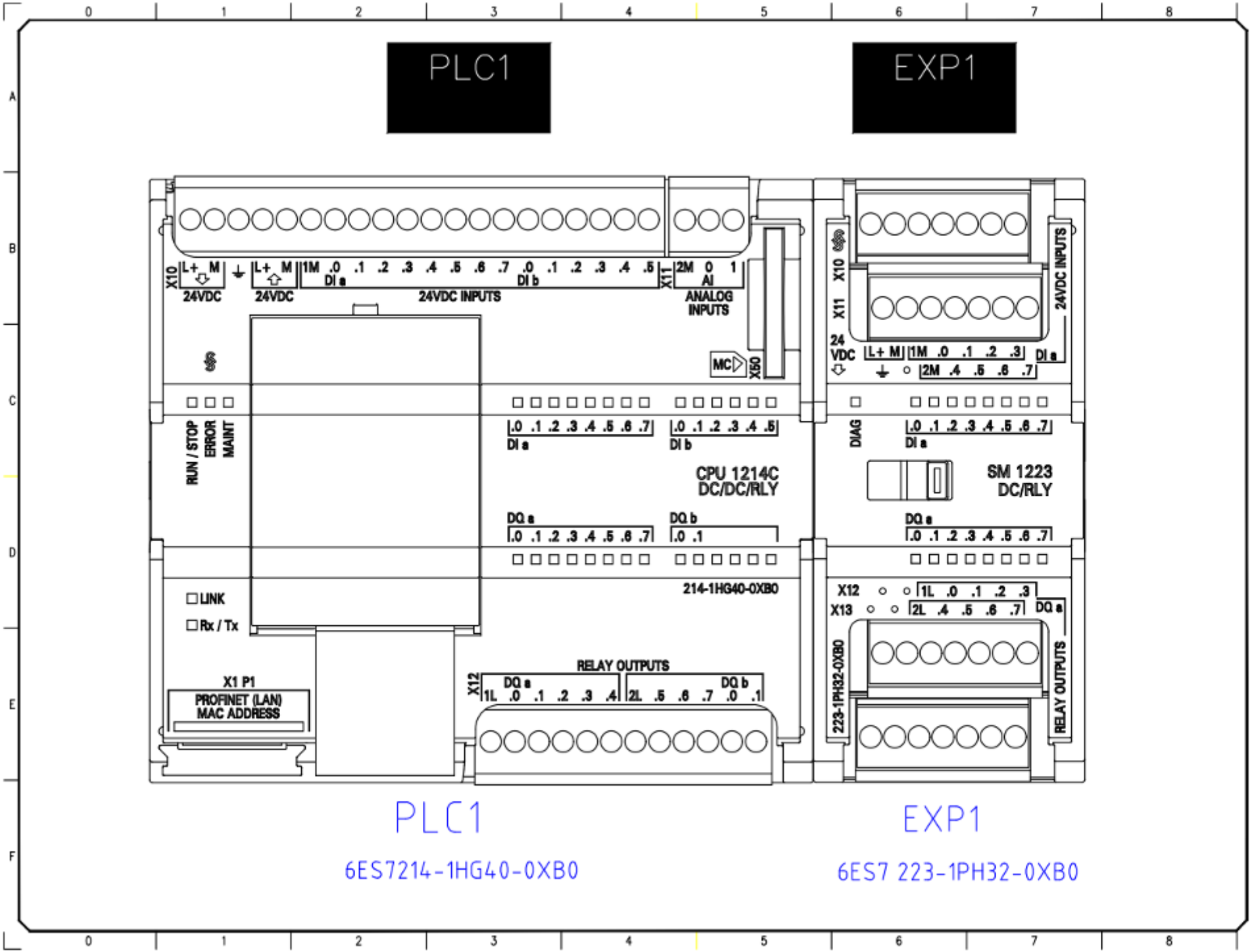

NO.	DATE	REV.	BY
DRAWING TITLE			
720103-002244			
AMX 370K COMB.			
APPROVED BY	DESIGNED BY		
DAVID F.	YOCMAJ		
DRAWN BY	DATE		
J.D.A.N.	16/5/17		
DRAWING NAME			
PLC CONFIG			
SHEET NO			
4 OF 15			

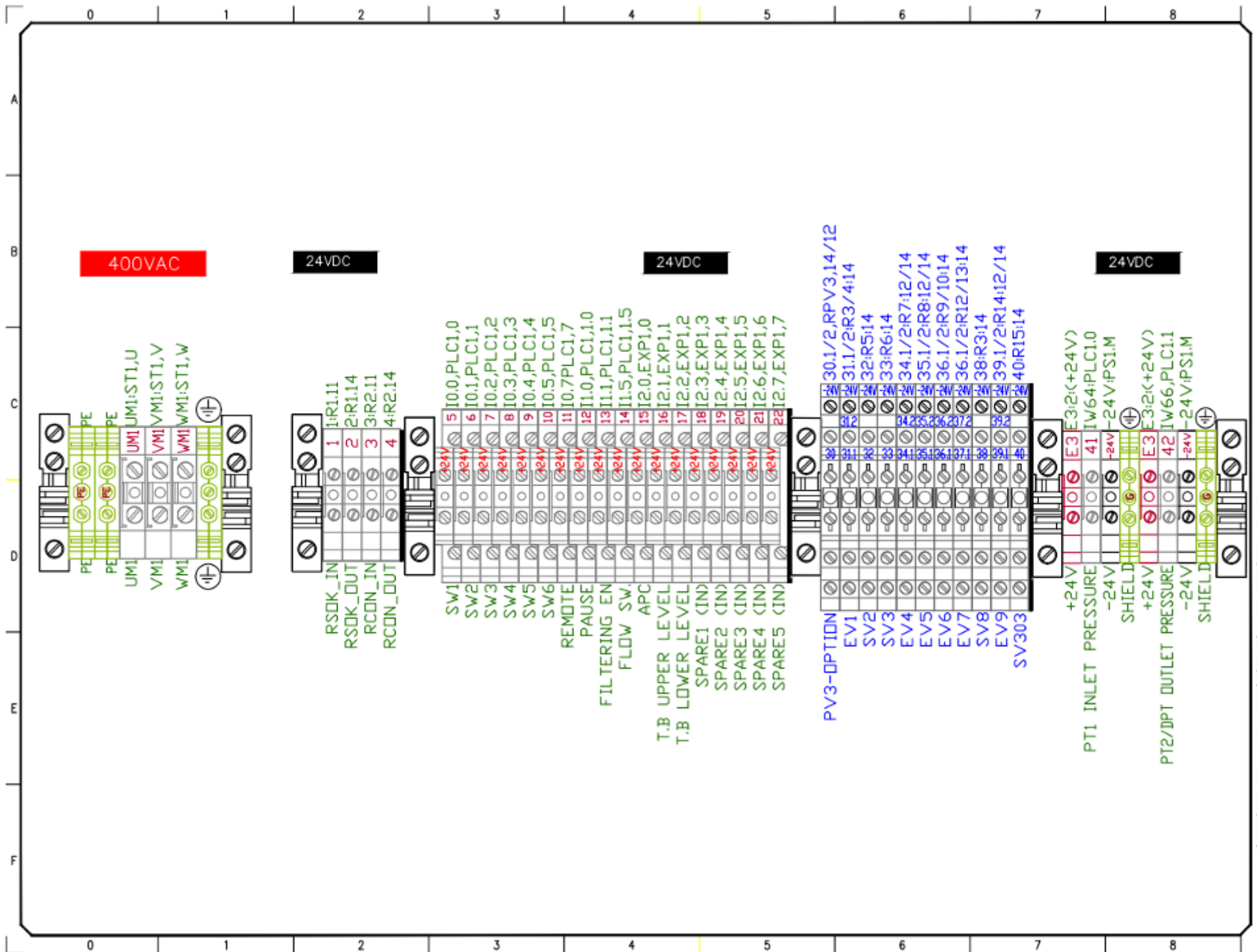

AMF 370K -S

02.2018

Page 72 of 86

AMAD

FILTMAT

ARKAL

pelemed WATER SYSTEMS

NO.	DATE	REV.	BY
DWS TITLE			
720102-002244			
AMF 370K COMB.			
APPROVED BY	CHECKED BY		
DAVID J.	YOCMAI		
JOB NO.	DRAWN BY		
	J.DAN		
REV.	DATE		
V.D	16/5/17		
DWS NAME			
TERMINAL PLAN			
SHEET NO.			
5 OF 15			

AMF 370K -S (NEW ENG) AMF 370K COMB (TERMINAL PLAN) DWS

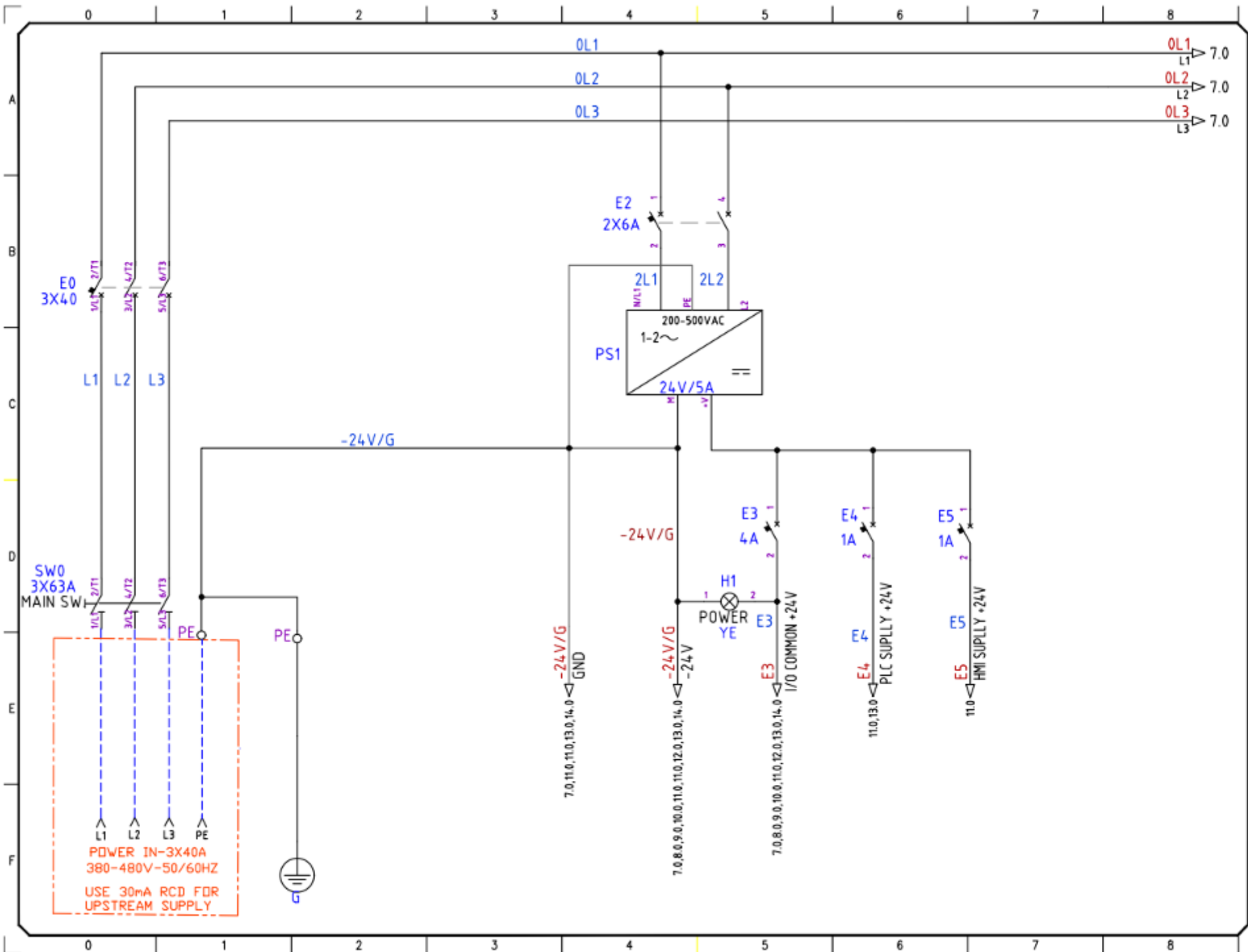





ARKAL



FILOMAT



AMIAD

NO.	DATE	REV.	BY
DWS TITLE			
720103-002244 AMF 370K COMB.			
APPROVED BY	CHECKED BY		
DAVID J.	YOCRAI		
JOB NO	DRAWN BY		
	J/DAN		
REV. V.D	DATE		
	16/5/17		
DWS NAME			
MAIN POWER			
SHEET NO			
6 OF 15			

P: VAC/24V/5A/200V/50/60HZ/3P/3W/3C/3L/3N/3PE/3G/3S/3T/3U/3V/3W/3X/3Y/3Z/3AA/3AB/3AC/3AD/3AE/3AF/3AG/3AH/3AI/3AJ/3AK/3AL/3AM/3AN/3AO/3AP/3AQ/3AR/3AS/3AT/3AU/3AV/3AW/3AX/3AY/3AZ/3BA/3BB/3BC/3BD/3BE/3BF/3BG/3BH/3BI/3BJ/3BK/3BL/3BM/3BN/3BO/3BP/3BQ/3BR/3BS/3BT/3BU/3BV/3BW/3BX/3BY/3BZ/3CA/3CB/3CC/3CD/3CE/3CF/3CG/3CH/3CI/3CJ/3CK/3CL/3CM/3CN/3CO/3CP/3CQ/3CR/3CS/3CT/3CU/3CV/3CW/3CX/3CY/3CZ/3DA/3DB/3DC/3DD/3DE/3DF/3DG/3DH/3DI/3DJ/3DK/3DL/3DM/3DN/3DO/3DP/3DQ/3DR/3DS/3DT/3DU/3DV/3DW/3DX/3DY/3DZ/3EA/3EB/3EC/3ED/3EE/3EF/3EG/3EH/3EI/3EJ/3EK/3EL/3EM/3EN/3EO/3EP/3EQ/3ER/3ES/3ET/3EU/3EV/3EW/3EX/3EY/3EZ/3FA/3FB/3FC/3FD/3FE/3FF/3FG/3FH/3FI/3FJ/3FK/3FL/3FM/3FN/3FO/3FP/3FQ/3FR/3FS/3FT/3FU/3FV/3FW/3FX/3FY/3FZ/3GA/3GB/3GC/3GD/3GE/3GF/3GG/3GH/3GI/3GJ/3GK/3GL/3GM/3GN/3GO/3GP/3GQ/3GR/3GS/3GT/3GU/3GV/3GW/3GX/3GY/3GZ/3HA/3HB/3HC/3HD/3HE/3HF/3HG/3HH/3HI/3HJ/3HK/3HL/3HM/3HN/3HO/3HP/3HQ/3HR/3HS/3HT/3HU/3HV/3HW/3HX/3HY/3HZ/3IA/3IB/3IC/3ID/3IE/3IF/3IG/3IH/3II/3IJ/3IK/3IL/3IM/3IN/3IO/3IP/3IQ/3IR/3IS/3IT/3IU/3IV/3IW/3IX/3IY/3IZ/3JA/3JB/3JC/3JD/3JE/3JF/3JG/3JH/3JI/3JJ/3JK/3JL/3JM/3JN/3JO/3JP/3JQ/3JR/3JS/3JT/3JU/3JV/3JW/3JX/3JY/3JZ/3KA/3KB/3KC/3KD/3KE/3KF/3KG/3KH/3KI/3KJ/3KK/3KL/3KM/3KN/3KO/3KP/3KQ/3KR/3KS/3KT/3KU/3KV/3KW/3KX/3KY/3KZ/3LA/3LB/3LC/3LD/3LE/3LF/3LG/3LH/3LI/3LJ/3LK/3LM/3LN/3LO/3LP/3LQ/3LR/3LS/3LT/3LU/3LV/3LW/3LX/3LY/3LZ/3MA/3MB/3MC/3MD/3ME/3MF/3MG/3MH/3MI/3MJ/3MK/3ML/3MN/3MO/3MP/3MQ/3MR/3MS/3MT/3MU/3MV/3MW/3MX/3MY/3MZ/3NA/3NB/3NC/3ND/3NE/3NF/3NG/3NH/3NI/3NJ/3NK/3NL/3NM/3NO/3NP/3NQ/3NR/3NS/3NT/3NU/3NV/3NW/3NX/3NY/3NZ/3OA/3OB/3OC/3OD/3OE/3OF/3OG/3OH/3OI/3OJ/3OK/3OL/3OM/3ON/3OO/3OP/3OQ/3OR/3OS/3OT/3OU/3OV/3OW/3OX/3OY/3OZ/3PA/3PB/3PC/3PD/3PE/3PF/3PG/3PH/3PI/3PJ/3PK/3PL/3PM/3PN/3PO/3PP/3PQ/3PR/3PS/3PT/3PU/3PV/3PW/3PX/3PY/3PZ/3QA/3QB/3QC/3QD/3QE/3QF/3QG/3QH/3QI/3QJ/3QK/3QL/3QM/3QN/3QO/3QP/3QQ/3QR/3QS/3QT/3QU/3QV/3QW/3QX/3QY/3QZ/3RA/3RB/3RC/3RD/3RE/3RF/3RG/3RH/3RI/3RJ/3RK/3RL/3RM/3RN/3RO/3RP/3RQ/3RR/3RS/3RT/3RU/3RV/3RW/3RX/3RY/3RZ/3SA/3SB/3SC/3SD/3SE/3SF/3SG/3SH/3SI/3SJ/3SK/3SL/3SM/3SN/3SO/3SP/3SQ/3SR/3SS/3ST/3SU/3SV/3SW/3SX/3SY/3SZ/3TA/3TB/3TC/3TD/3TE/3TF/3TG/3TH/3TI/3TJ/3TK/3TL/3TM/3TN/3TO/3TP/3TQ/3TR/3TS/3TT/3TU/3TV/3TW/3TX/3TY/3TZ/3UA/3UB/3UC/3UD/3UE/3UF/3UG/3UH/3UI/3UJ/3UK/3UL/3UM/3UN/3UO/3UP/3UQ/3UR/3US/3UT/3UU/3UV/3UW/3UX/3UY/3UZ/3VA/3VB/3VC/3VD/3VE/3VF/3VG/3VH/3VI/3VJ/3VK/3VL/3VM/3VN/3VO/3VP/3VQ/3VR/3VS/3VT/3VU/3VV/3VW/3VX/3VY/3VZ/3WA/3WB/3WC/3WD/3WE/3WF/3WG/3WH/3WI/3WJ/3WK/3WL/3WM/3WN/3WO/3WP/3WQ/3WR/3WS/3WT/3WU/3WV/3WW/3WX/3WY/3WZ/3XA/3XB/3XC/3XD/3XE/3XF/3XG/3XH/3XI/3XJ/3XK/3XL/3XM/3XN/3XO/3XP/3XQ/3XR/3XS/3XT/3XU/3XV/3XW/3XX/3XY/3XZ/3YA/3YB/3YC/3YD/3YE/3YF/3YG/3YH/3YI/3YJ/3YK/3YL/3YM/3YN/3YO/3YP/3YQ/3YR/3YS/3YT/3YU/3YV/3YW/3YX/3YY/3YZ/3ZA/3ZB/3ZC/3ZD/3ZE/3ZF/3ZG/3ZH/3ZI/3ZJ/3ZK/3ZL/3ZM/3ZN/3ZO/3ZP/3ZQ/3ZR/3ZS/3ZT/3ZU/3ZV/3ZW/3ZX/3ZY/3ZZ

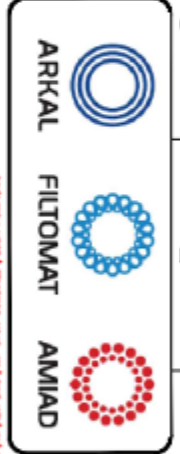
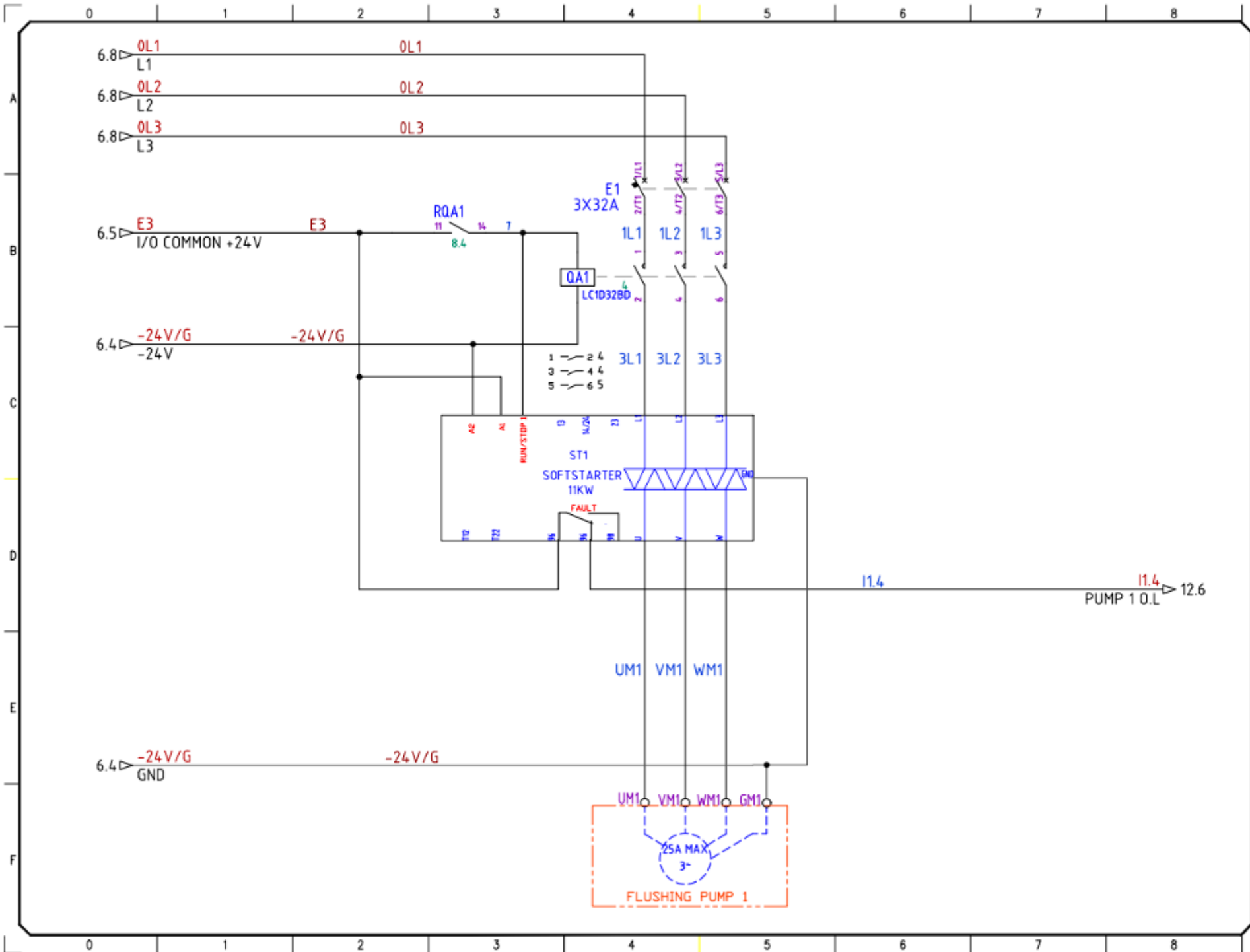

NO.	DATE	REV.	BY
DWS TITLE			
720103-002244			
AMF 370K COMB.			
APPROVED BY		CHECKED BY	
DAVID L.		YICRAI	
JOB NO.		DRAWN BY	
J.DAN		J.DAN	
REV.	V.D.	DATE	16/5/17
DWS NAME			
FLUSH PUMP			
SHEET NO.			
7 OF 15			

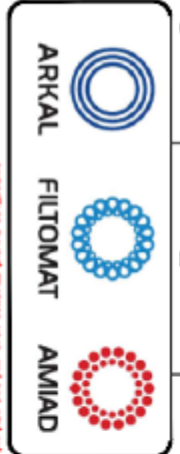
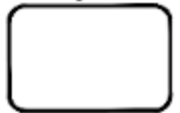
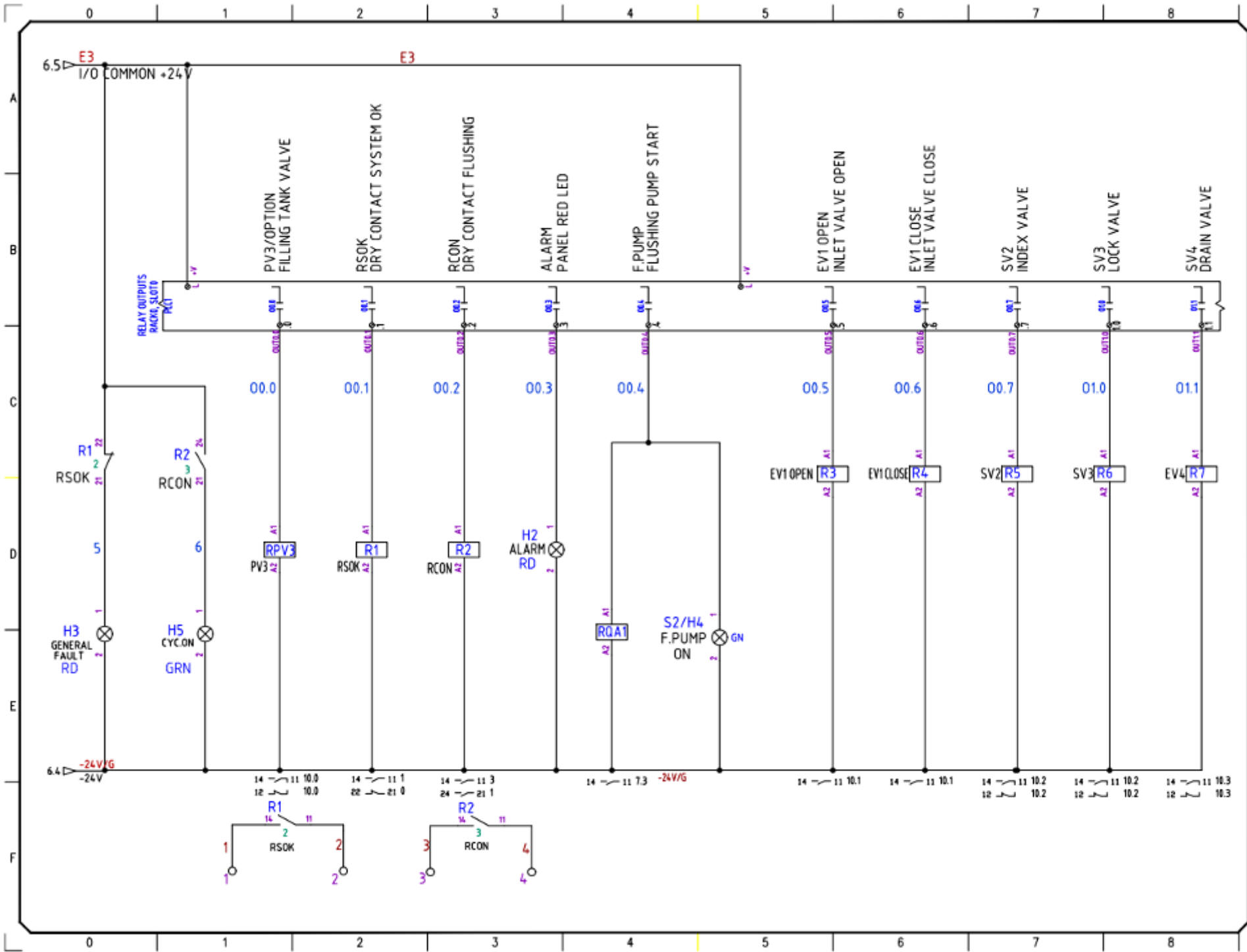

NO.	DATE	REV.	BY
DWS TITLE 720H2-082244 ARK 370K COMB.			
APPROVED BY DAVID J. YOCUM		CHECKED BY J.DAN	
JOB NO. 		DATE 16/5/17	
DWS NAME DIGITAL OUT_00			
SHEET NO. 8 OF 15			

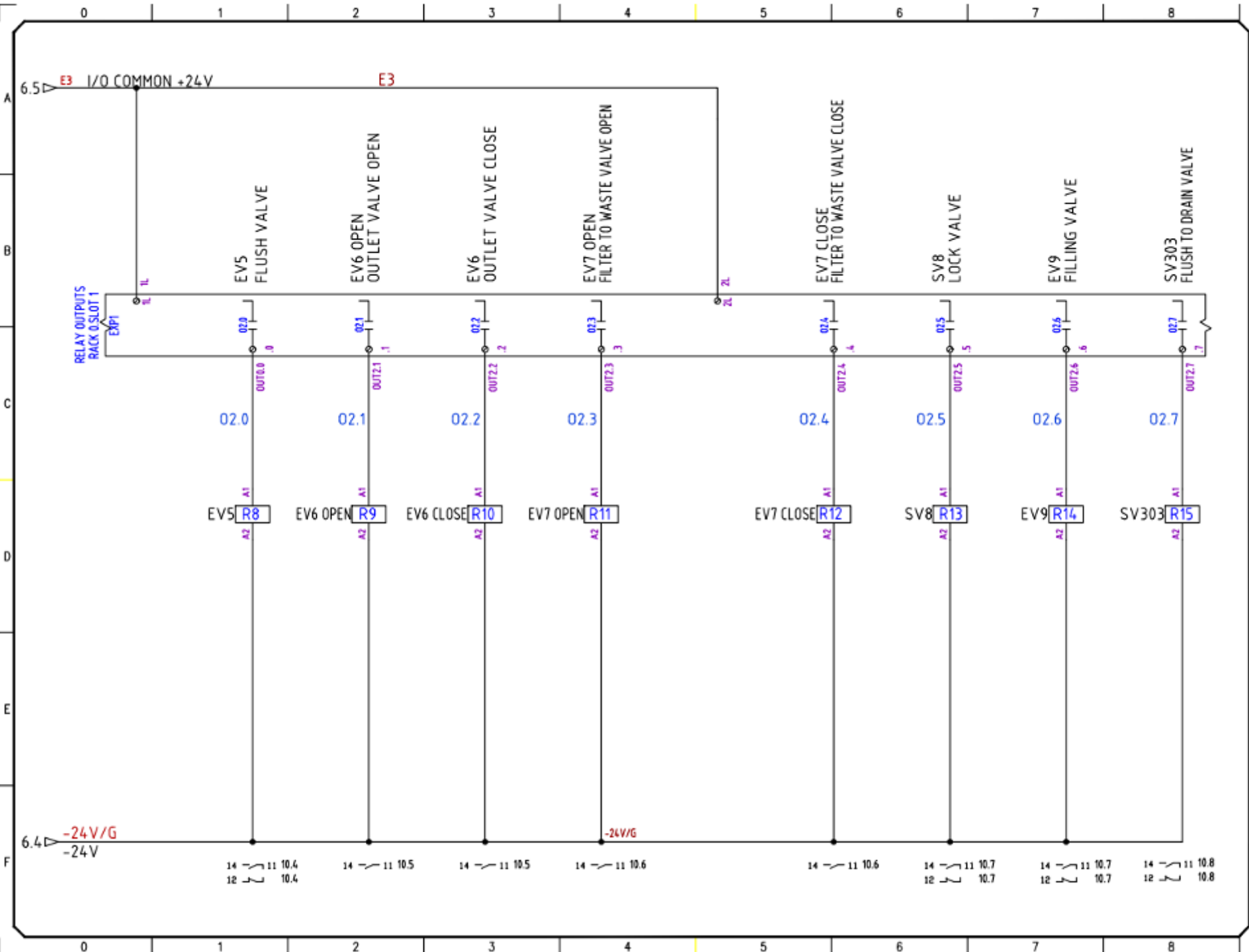

9



NO.	DATE	REV.	BY
DWG TITLE			
720102-002244			
AMK 370K COMB.			
APPROVED BY	CHECKED BY		
DAVID L	YOSHAF		
DRAWN BY			
I/DAN			
DATE			
16/5/17			
DWO NAME			
DIGITAL OUT_10			
SHEET NO			
8 OF 15			

P:\AMK 370K COMB\AMF 370K AMF 370K COMB\DIGITAL OUT_10.DWG
 7/20/2017 10:02:34 AM
 16/5/17 10:02:34 AM

9

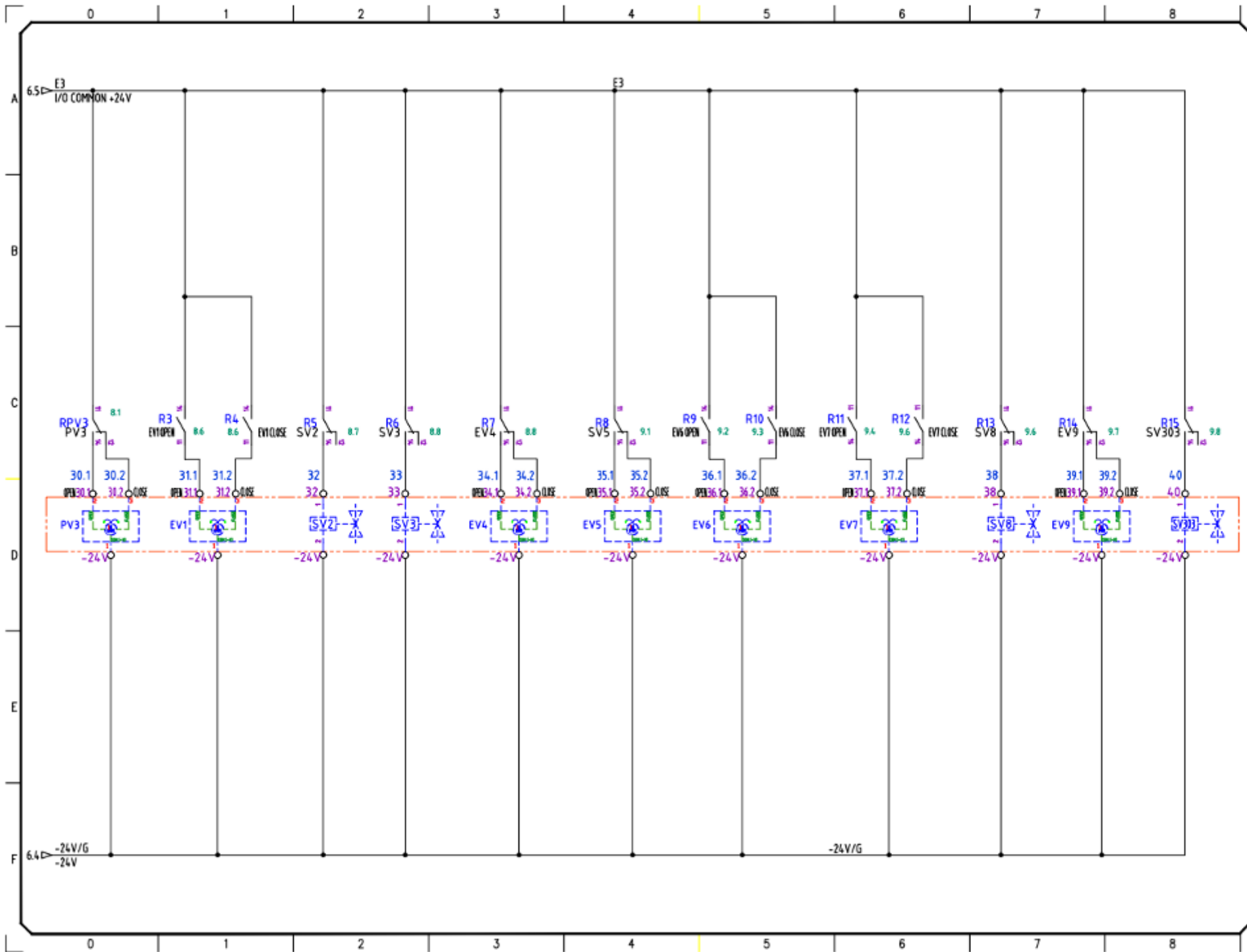

9

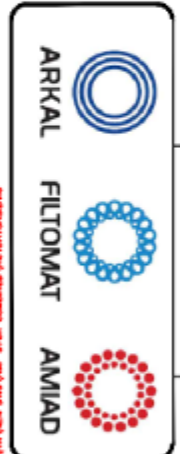

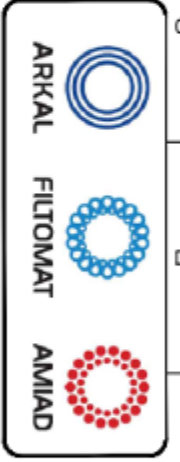
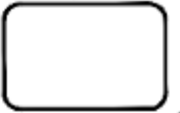
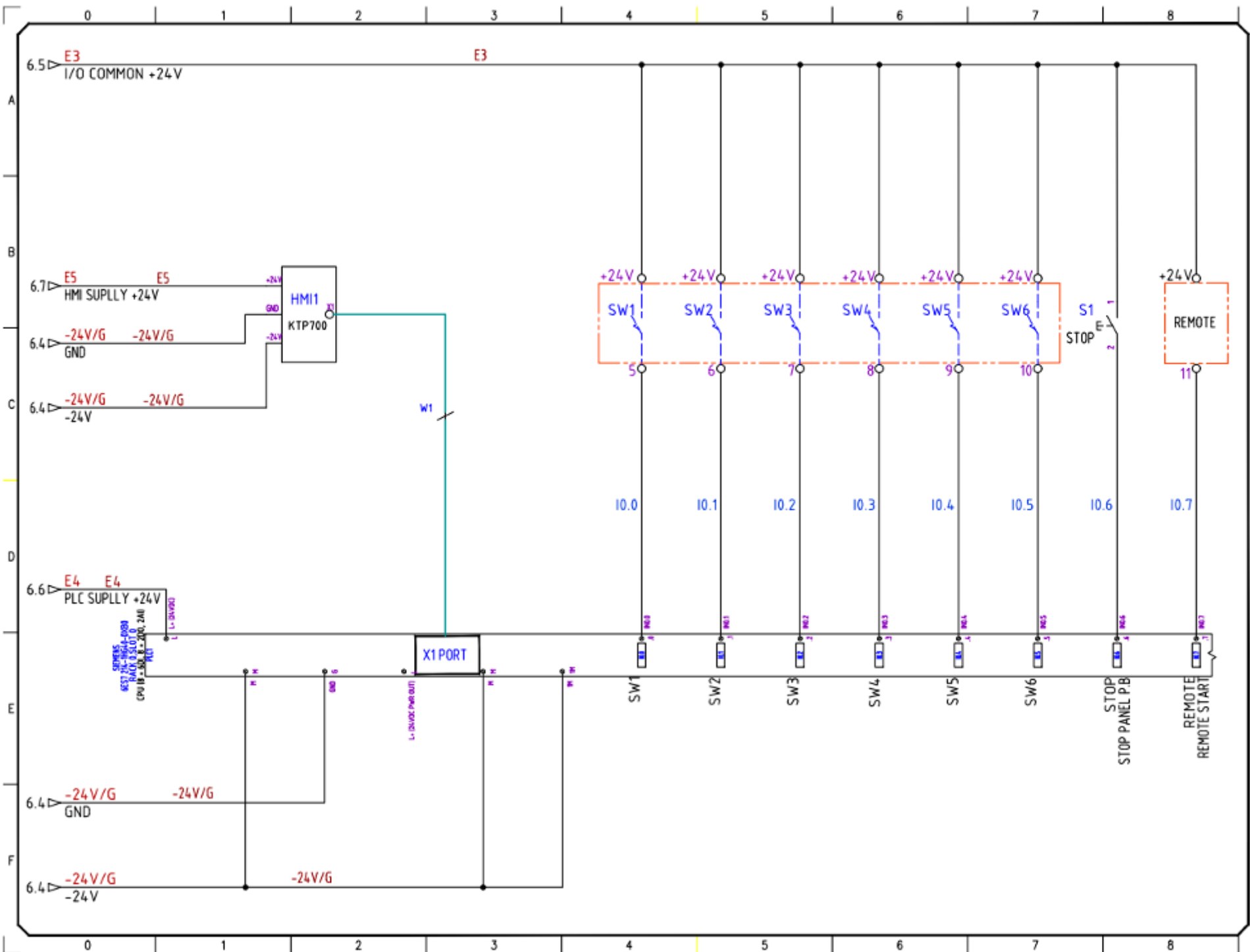

NO.	DATE	REV.	BY
DWS TITLE			
720102-002244			
AMF 370K COMB.			
APPROVED BY	CHECKED BY		
DAVID L.	YOCRAJ		
DWG NO	DRAWN BY		
	J.DAN		
REV	DATE		
Y.D	18/5/17		
DWS NAME			
ACTUATORS			
SHEET NO			
10 OF 15			

D:\PROJECTS\ACTUATORS\370K_S\AMF_370K_S\AMF_370K_S\DWG\370K_S\370K_S.dwg
 18/05/17 10:10:17 AM

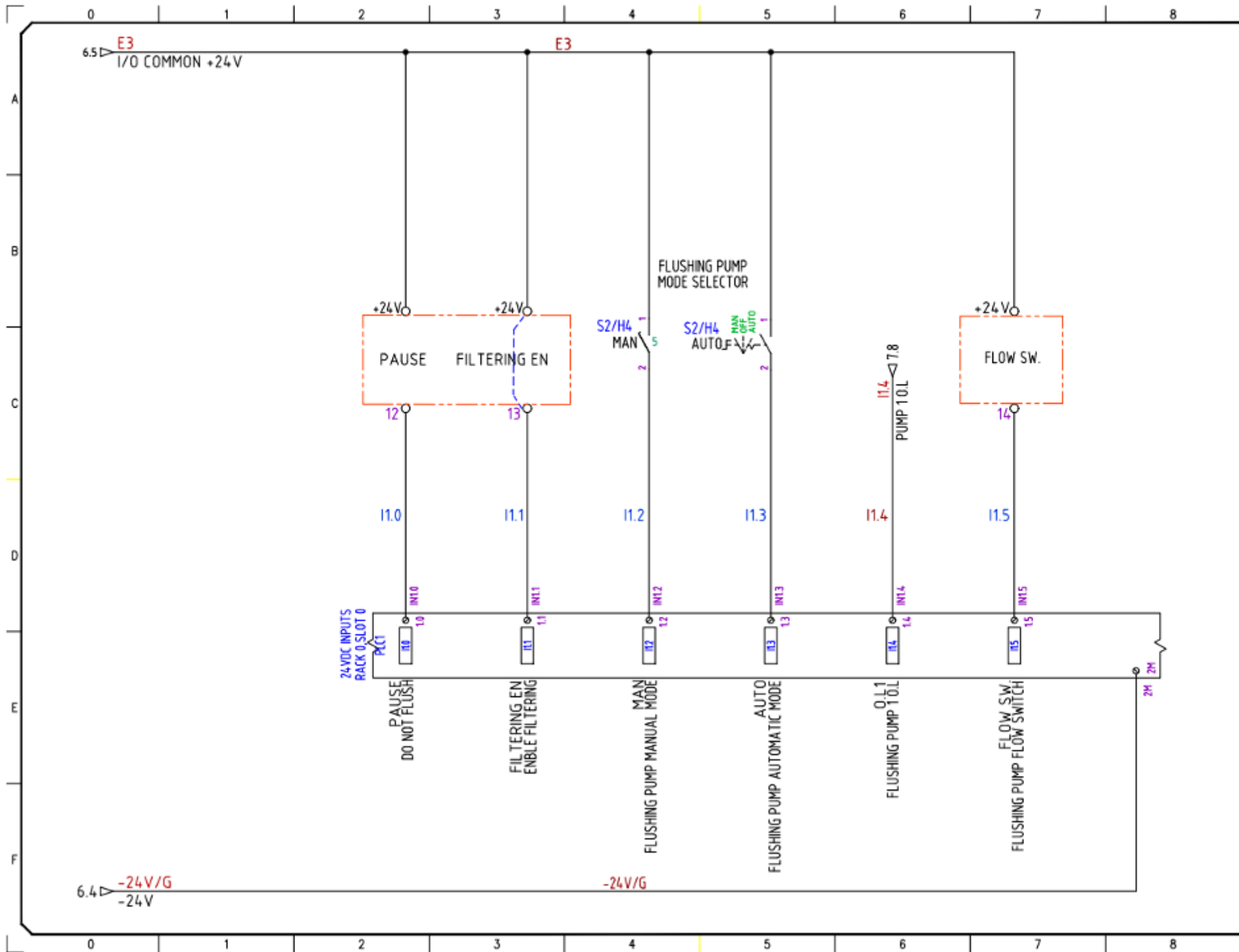

NO.	DATE	REV.	BY
750102-002244			
ARK 370K COMB.			
APPROVED BY	CHECKED BY		
DAVID I.	YOCHAI		
JOB NO	DRAWN BY		
	J/DAN		
REV.	DATE		
V.D	16/5/17		
DWO NAME			
DIGITAL IN_00			
SHEET NO			
11 OF 15			







Amiad
WATER SYSTEMS



ARKAL



FILTOMAT



AMIAD

NO.	DATE	REV.	BY
720102-002244 AMX 370K COVER			
APPROVED BY	DESIGNED BY	CHECKED BY	DRAWN BY
REV. V.D.	DATE		
	15/5/17		
DIGITAL IN_01 SHEET NO 12 OF 15			

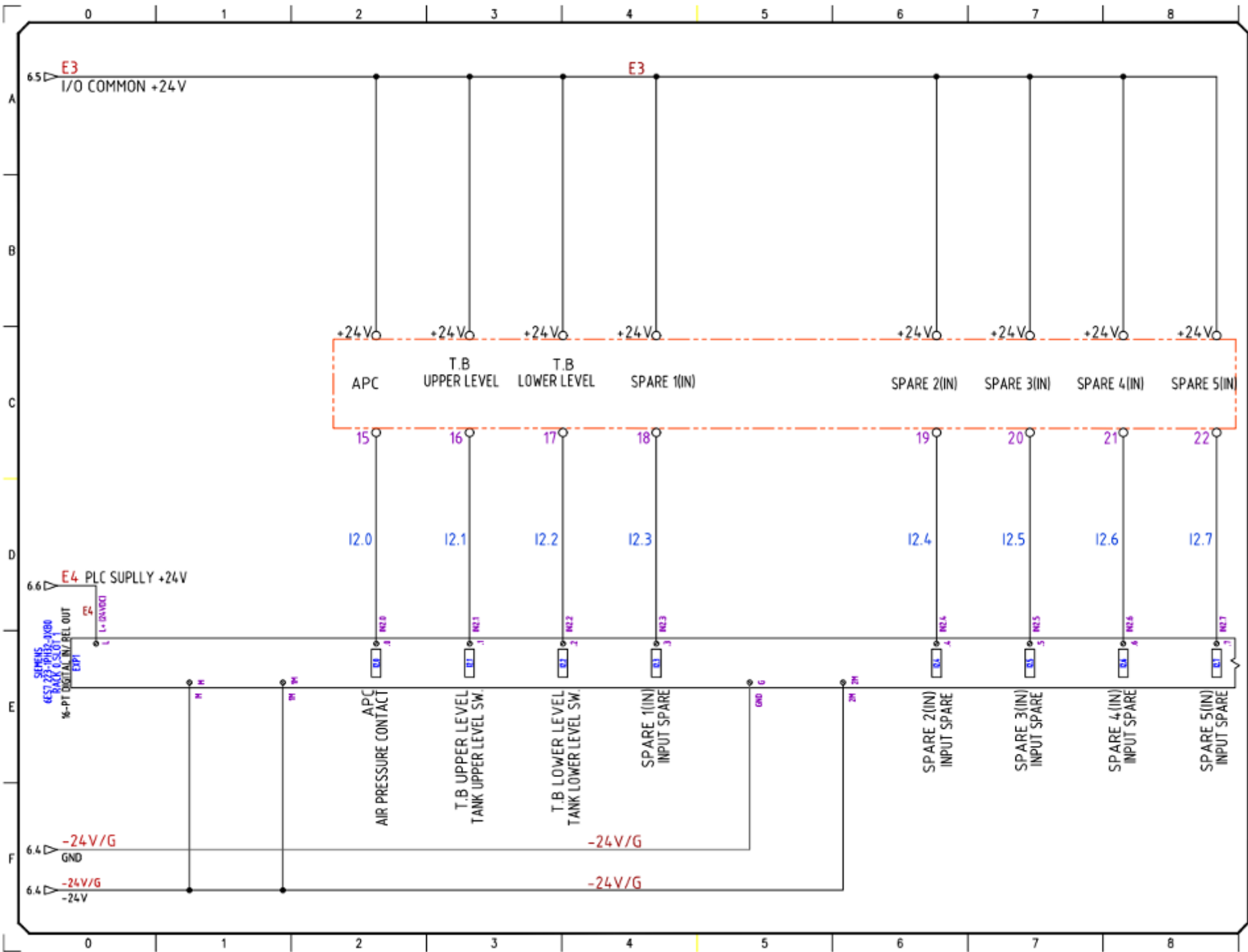

9
A



C

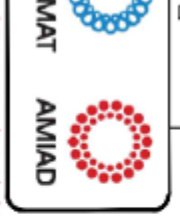

NO.	DATE	REV.	BY
720102-002244			
AMK 370K COMB.			
APPROVED BY	YOSHAI	CHECKED BY	J/DAN
DRAWN BY	J/DAN	DATE	16/5/17
DIGITAL IN_10			
13 OF 15			

FILE: \\ARCHE\SYSTEMS\AMF_370K_COMBINED\DIGITAL_IN_10.DWG
 PLOT: \\ARCHE\SYSTEMS\AMF_370K_COMBINED\DIGITAL_IN_10.DWG

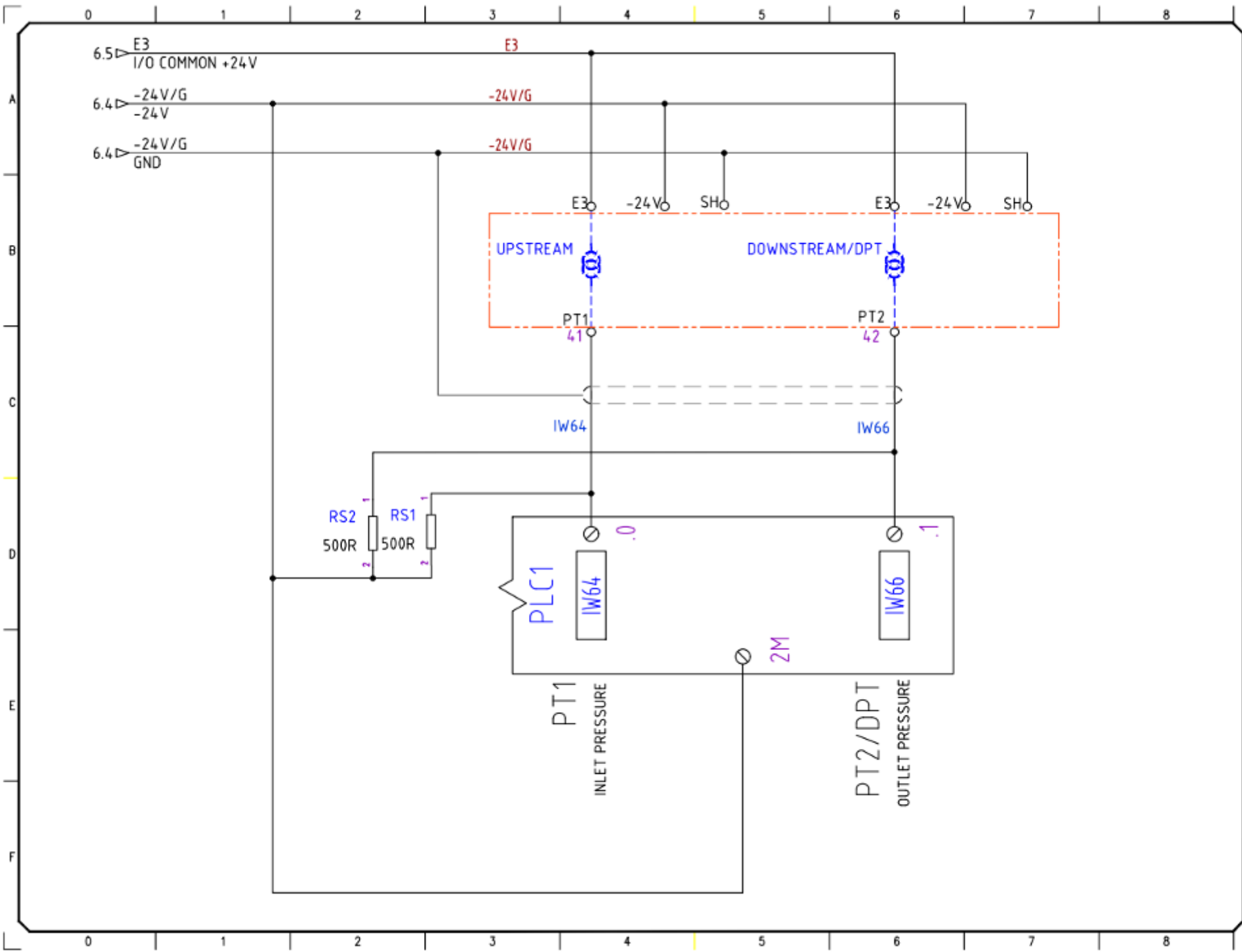

NO. DATE REV. BY
 DWG TITLE
 720V03-002344
 AMF 370K COMB.

APPROVED BY: DAVID J. TUCRAL
 CHECKED BY: TUCRAL
 JOB NO. DRAWN BY: IDAN

REV. V.D. DATE: 16/5/17

DWG NAME: ANALOG IN_00
 SHEET NO: 14 OF 15

TAGS	MFG	AMIAID P/N	QTY	CATALOG	DESC	RATING/RANGE/TYPE
EN1	SCHNEIDER ELECTRIC	720209-000121	1	NSYPLM75G	POLYESTER ENCLOSURE,PLM75 747x536x300	IP66
EN1	SCHNEIDER ELECTRIC	720209-000127	1	NSYMM75	PLATE, MOUNTING FOR PLM75 655X450	655X450
EN1	SCHNEIDER ELECTRIC	720209-000138	1	NSYPAP75G	INNER DOOR FOR PLM75	POLYESTER
EN1	SCHNEIDER ELECTRIC	720209-000039	1	NSYFPPLMG	BRACKETS SET FOR NSYPLM	POLYESTER
SW0	SCHNEIDER ELECTRIC	720206-000035	1	VCF3	SWITCH-DISCONNECTOR I - 3P - 63 A	3X63A
E0	SCHNEIDER ELECTRIC	720213-000120	1	A9F74340	CIRCUIT BREAKER C TYPE 3 POLES -40A	40AMP
E1	SCHNEIDER ELECTRIC	720213-000047	1	A9F74332	CIRCUIT BREAKER C TYPE 3 POLES -32A TYPE C	3X32A
E2	SCHNEIDER ELECTRIC	720213-000036	1	A9F74206	CIRCUIT BREAKER C TYPE 2 POLES - 6A	6AMP
E3	SCHNEIDER ELECTRIC	720213-000028	1	A9F74104	CIRCUIT BREAKER C TYPE 1 POLES - 4A	4AMP
E4,E5	SCHNEIDER ELECTRIC	720213-000026	2	A9F74101	CIRCUIT BREAKER C TYPE 1 POLES - 1A	1X1A
ST1	SIEMENS	720218-000012	1	3RW40268B4	SOFT STARTER 11KW	11KW
QA1	SCHNEIDER ELECTRIC	720217-000123	1	LC1D328D	CONTACTOR TESYS LC1-D - 3P - AC-3 440V 32A - COIL 24VDC	24VDC
R1,R2	PHOENIX CONTACT	720217-000113	2	2900931	RIF-1-BPT/2X21 SOCKET FOR RELAY	RIF-1-BPT/2X21
R1,R2	PHOENIX CONTACT	720217-000114	2	2904468	Retaining bracket - RIF-RH-1-H	
R1,R2	PHOENIX CONTACT	720217-000112	2	2987943	REL-MR- 24DC/21-21/M5 BA 24VDC RELAY	24VDC
R3-15,RPV3,RQA1	PHOENIX CONTACT	720217-000115	15	2903370	SLIM RELAY RIF-0-RPT-24DC/21 6A	24VDC
HMI1	SIEMENS	720101-000628	1	6AV2123-2GB03-0AXD	KTP700 Touch - 7" Colour Touch + 8 Function keys	HMI KTP700
EXP1	SIEMENS	720101-000422	1	6ES7223-1PH32-0XB0	SIMATIC S7-1200 - SM 1223,8 X 24V DC INPUT/8 XRELAY OUTPUT	DISCRETE COMBINATION
PLC1	SIEMENS	720101-000419	1	6ES7214-1HG40-0XB0	SIMATIC S7-1200 -CPU 1214C DC/DC/RLY	CPU
W1	BEIDEN	720205-000084	1	LAN CABLE CAT5 RG45	HMI-PLC CABLE, 'ETHERNET CABLE	ETHERNET CABLE 2M
PS1	SCHNEIDER ELECTRIC	720216-000046	1	ABLBRP524050	REGULATED SWITCH MODE POWER SUPPLY, PHASED UNIVERSAL RANGE	SINGLE/TWO-PHASE
S1	SCHNEIDER ELECTRIC	720210-000040	1	ZB5AA4	PUSHBUTTON HEAD - Ø22 - RED	RED
S1	SCHNEIDER ELECTRIC	720210-000049	1	ZB5AZ101	BODY FOR CONTROL BUTTON - Ø22 - 1NO	PLASTIC
S2/H4	SCHNEIDER ELECTRIC	720210-000062	1	ZB5AK1333	ILLUMINATED SELECTOR SWITCH HEAD - 3 POSITIONS Ø22 - GREEN, STAY PUT	GREEN
S2/H4	SCHNEIDER ELECTRIC	720210-000063	1	ZBVB3	GREEN LED 24VDC	24V
S2/H4	SCHNEIDER ELECTRIC	720210-000088	1	ZB5AZ103	BODY FOR CONTROL BUTTON - Ø22 - 2NO	40AMPS
H2,H3	SCHNEIDER ELECTRIC	720210-000052	2	XB5AVB4	ROUND PILOT LIGHT Ø22 - IP 65 - RED - INTEGRAL LED - 24V - LUGS	24V
H1	SCHNEIDER ELECTRIC	720210-000053	1	XB5AVB5	ROUND PILOT LIGHT Ø22 - IP 65 - YELLOW - INTEGRAL LED - 24V - LUGS	24V
H5	SCHNEIDER ELECTRIC	720210-000051	1	XB5AVB3	ROUND PILOT LIGHT Ø22 - IP 65 - GREEN - INTEGRAL LED - 24V - LUGS	24V
H1,H2,H3,H5,S1	AB	720210-000055	5	800F-12BE100	SIGN HOLDER FOR 22mm EQU	SIGN HOLDER
BRG	PHOENIX CONTACT	720220-000001	3	203250	Fixed bridge, Number of positions: 10, Color: silver	
TBB	PHOENIX CONTACT	720220-000003	2	711344	UNIVERSAL TERMINAL BLOCK - UK 5N BK	41AMPS
BF2	PHOENIX CONTACT	720220-000004	1	2770024	BUFFER FOR 2LEVEL TERMINAL BLOCK - UKK 5	BUFFER
TB2	PHOENIX CONTACT	720220-000005	18	2774017	2LEVEL TERMINAL BLOCK - UKK 5	32AMPS
BF1	PHOENIX CONTACT	720220-000006	1	3003020	BUFFER FOR TERMINAL BLOCK - UKK 5	BUFFER
TB1	PHOENIX CONTACT	720220-000007	6	3004362	UNIVERSAL TERMINAL BLOCK - UK 5 N	
TBG-6	PHOENIX CONTACT	720220-000002	3	442079	UNIVERSAL GROUND TERMINAL BLOCK - USLKG 6 N	
TB1-6	PHOENIX CONTACT	720220-000010	3	3004524	UNIVERSAL TERMINAL BLOCK - UK 6 N	32AMPS
TB3	PHOENIX CONTACT	720220-000018	11	3214259	3LEVEL TERMINAL BLOCK - UKK 5	BUFFER
BF3	PHOENIX CONTACT	720220-000019	1	3214314	BUFFER FOR 3LEVEL TERMINAL BLOCK - UKK 5	
BRG3	PHOENIX CONTACT	720220-000020	1	3030213	RED BRIDGES FOR 3 LEVEL TERMINALS	41AMPS
TBR	PHOENIX CONTACT	720220-000009	2	3026696	UNIVERSAL TERMINAL BLOCK - UK 5N RD	
ST	PHOENIX CONTACT	720220-000014	15	3022218	END CLAMP - E/UK	GND
TBG	PHOENIX CONTACT	720220-000016	2	441504	GROUND TERMINAL BLOCK - USLKG 5	SLOTTED
TERMINAL LABELS TM-5	PHOENIX CONTACT	720220-000033	66	828734	THERMOMARK LABEL FOR TERMINALS 2.5 mm UTC-TM 5	PC
TERMINAL LABELS TM-6	PHOENIX CONTACT	720220-000015	110	828736	THERMOMARK LABEL FOR TERMINALS 4mm UTC-TM 6	PC
WIRE LABELS	PHOENIX CONTACT	720220-000032	500	828570	THERMOMARK LABEL FOR WIRES 1.5-3.2mm ²	PC
SIGNS 17X15	PHOENIX CONTACT	720220-000026	6	828793	THERMOMARK STICK ON LABEL WHITE 17.5X15	PC
SIGNS 27X15	PHOENIX CONTACT	720220-000027	15	828799	THERMOMARK STICK ON LABEL WHITE 27X15	PC
SIGNS 35X15	PHOENIX CONTACT	720220-000028	2	830321	THERMOMARK STICK ON LABEL RED 35X15	PC
CE STICKER		900102-000097	1		CE STANDART APPROVAL STICKER	30mm
DIN_L	N/A		700mm		ZINC/STEEL DIN RAIL EN 50022 (35mm x 7.5mm x 1m)	SLOTTED
SIN_H	N/A		350mm		HIGH RAISE DIN RAIL 30'	500R
RS1,RS2	N/A		2		500 OHM RESISTOR 1/4W 1%	3X05-0.75
CABLE	N/A		4M		SHIELDED CABLE 2+SHEILD	





NO.	DATE	REV.	BY
DWG TITLE 720102-002844 AMF 370K COMB.			
APPROVED BY	DRAWN BY	CHECKED BY	DATE
DAVID L.	JOCVAL	JDAH	16/5/17
REV. V.D.	DATE		
DWG NAME BOM			
SHEET NO 15 OP 15			

6. Maintenance Instructions

This chapter describes the AMF 370K-S filter maintenance instructions in general; the maintenance schedule depends heavily on the actual conditions of each installation site.

The required maintenance schedule is determined by factors such as water quality, raw water corrosivity, the presence and types of dissolved chemicals, dirt load, total suspended solids level, number of daily flush cycles and other such factors. Therefore it is important to set the maintenance schedules according to the specific site conditions.

Please note that in light of the above paragraph the following instructions are based on a system that flushes 24 times a day.

Remarks:

- There is no need to oil or grease any moving parts in this filter
- Seals and static O-rings in this filter should be greased only with silicon grease that is approved for potable water usage.
- See the parts schedule chapter for identifying the parts mentioned in the following instructions

6.1. Daily and weekly maintenance

Regularly there is no need for a daily maintenance at the AMF 370K-S filter; anyway operators who wish to maintain a daily maintenance schedule are requested to perform daily the following weekly maintenance instructions:

- Start a manual flushing cycle by pressing the start cycle button at the filter's control board. Monitor the flushing process and verify that it performed and completed correctly.
- Visually check the filter for leaks, fix if necessary.
- Check the compressed air supply of the filter and drain water from the pneumatic system.
- Check the filter vicinity and remove any foreign objects and debris.

6.2. Annual maintenance

Prior to the annual maintenance it is important to disconnect the AMF 370K-S filter from the water system to remove the cartridges out of its housing.

Filter housing:

- Carefully check the coating and the painting of the outer and inner housing of filter for any wear and tear, correct accordingly.
- Check the inner 2" guide pipes of the filter and replace defected or worn pipes.
- Check the seals of all the filter's lids and replace if necessary.

Main piston coating:

- Carefully check the coating and the painting of the main piston for wear and tear and correct accordingly.

Piston #100:

- Carefully check the piston, replace any worn part.
- Check the piston house guide and replace if worn.

- Check the stainless steel cylinder and replace if worn.
- Replace the piston's U-rings.

Piston #76:

- Carefully check the piston, replace any worn part.
- Check and replace the bearing guides and the pin wear plates.
- Check the spraying nozzles for clogging, clean or replace accordingly.
- Check the spraying nozzles for wear and tear, replace if necessary.
- Check the spraying system for loosen parts or too large tolerances, correct accordingly.
- Replace the tail pipe U-ring seal assembly.

Cartridges:

- Check the cartridges for wear and tear. If necessary replace the shaft bearing.
- Carefully check all the cassettes. If worn cassettes are found call Amiad technician for replacing the worn cassettes. (This operation should be done only by authorized Amiad technician.)
- Check the partition end bearings at the end of the cartridges and replace if necessary.
- Replace the partition plates U-rings and O-rings.
- Check the stop ring of brake and replace if worn.
- Check the gear wheel and replace if worn.

Index Piston:

- Carefully check the piston, replace any worn part.
- Replace the cylinder U-rings and guide strips.
- Replace the shaft U-rings
- Tighten the shaft/connector.

The drive mechanism:

- Check the push blocks and spring guides for free movement and tolerance, correct if necessary.
- Tighten all the bolts of this mechanism.

The tail assembly:

- Check the tail pipe assembly for wear and tear, correct if necessary.

Auxiliary subsystem:

- Check and maintain the auxiliary subsystem components; pumps, valves, solenoids, etc. according to their manufacturer instructions.

7. AMIAD LIMITED WARRANTY

This certificate applies to Amiad Products purchased by You from Amiad or an Amiad authorized Distributor (“**Distributor**”). This limited warranty extends only to the original purchaser, and is not transferable to anyone who subsequently purchases, leases, or otherwise obtains the Product from the original purchaser.

1. Amiad hereby warrants that the Products are and will be free from defects in material and workmanship under normal use and service. Amiad warrants that it will correct manufacturing defects in the Products, in accordance with the conditions set out in this warranty.
2. This warranty is enforceable for a period of 12 months after the date Bill of Lading or equivalent (the “**Warranty Period**”).
3. In the event that during the Warranty Period the Distributor discovers a defect in material and/or workmanship in any Product or part (the “**Defective Product**”), it shall submit a written complaint to Amiad using Amiad's standard customer complaint form. For the receipt of the customer complaint form, the submission of the complaint or any questions please contact your customer service representative.
4. Upon written demand by Amiad the Distributor shall return the Defective Products – or a sample thereof – to Amiad, at Amiad's cost. If the customer ships any such Product, Amiad suggests the customer package it securely and insure it for value, as Amiad assumes no liability for any loss or damage occurring during shipment. Provided however that in the event Amiad determines that the warranty does not apply to such Product, Distributor shall promptly reimburse Amiad for such cost (including freight and customs). Any returned Product or part must be accompanied by the warranty certificate and the purchase invoice. It is clarified that the Distributor may not return the Defective Product unless such return was coordinate and approved by Amiad in advance.
5. Amiad's obligation under this warranty shall be limited to, at its option, the repair or exchange, free of charge, of the Product or any part which may prove defective under normal use and service during the Warranty Period. The provision of a repaired or replacement Product during the Warranty Period will result in an extension of the Warranty Period by an additional period of 12 months, provided that the total accumulated Warranty Period shall in any event be no more than 18 months from the original Bill of Lading.
6. This warranty is valid on the condition that the Products are installed according to Amiad's instructions as expressed in Amiad's instruction manuals and according to the technical limitations as stipulated in Amiad's literature or as stated by a representative of Amiad.
7. This warranty will not apply to damaged or defective Products resulting from or related to:
 - (i) Fire, flood, power surges or failures or any other catastrophe/and or unforeseen occurrence, such as but not limited to those for which the customers are customarily insured;
 - (ii) Fault, abuse or negligence of the customer;
 - (iii) Customer's responsibilities, including the failure of the intake water to meet the agreed standards, as set forth in a written document, approved by Amiad or improper storage.
 - (iv) Improper or unauthorized use of the Product or related parts by the customer, including the customer's failure to operate the Product in conformity with the recommendations and instructions of Amiad, as set forth in Amiad's manuals and other written materials, the operation of the Product other than by a trained and qualified operator, or improper installation of the Product by a third party not authorized by Amiad;
 - (v) Performance by the customer of maintenance and other services other than by a trained and qualified advanced operator, or other than in conformity with the recommendations and instructions of Amiad, or other than in accordance with procedures defined in the literature supplied for Products;
 - (vi) Any alteration, modification foreign attachment to or repair of the Products, other than by Amiad or its authorized technical representatives.
8. In no event shall Amiad be liable to the customer or any third party for any damages, including indirect, special, exemplary, punitive or consequential damages, or lost profits arising out of or in connection with this warranty, or arising out of or in connection with the Product's performance or failure to perform, even if it has been advised of the possibility of such damages.
9. Amiad will be excused for failure to perform or for delay in performance hereunder if such failure or delay is due to causes beyond its reasonable control or force majeure preventing or hindering performance.
10. The limited warranty set forth herein is the only warranty given by Amiad and is provided in lieu of any other warranties created by any documentation, packaging or otherwise.
11. Amiad makes no warranty whatsoever in respect of accessories or parts not supplied by Amiad. In the event that Amiad is required to correct a defective Product or product not covered by this warranty, it will do so solely in consideration for additional fees.

Алматы (7273)495-231
Ангарск (3955)60-70-56
Архангельск (8182)63-90-72
Астрахань (8512)99-46-04
Барнаул (3852)73-04-60
Белгород (4722)40-23-64
Благовещенск (4162)22-76-07
Брянск (4832)59-03-52
Владивосток (423)249-28-31
Владикавказ (8672)28-90-48
Владимир (4922)49-43-18
Волгоград (844)278-03-48
Вологда (8172)26-41-59
Воронеж (473)204-51-73
Екатеринбург (343)384-55-89

Иваново (4932)77-34-06
Ижевск (3412)26-03-58
Иркутск (395)279-98-46
Казань (843)206-01-48
Калининград (4012)72-03-81
Калуга (4842)92-23-67
Кемерово (3842)65-04-62
Киров (8332)68-02-04
Коломна (4966)23-41-49
Кострома (4942)77-07-48
Краснодар (861)203-40-90
Красноярск (391)204-63-61
Курск (4712)77-13-04
Курган (3522)50-90-47
Липецк (4742)52-20-81

Магнитогорск (3519)55-03-13
Москва (495)268-04-70
Мурманск (8152)59-64-93
Набережные Челны (8552)20-53-41
Нижний Новгород (831)429-08-12
Новокузнецк (3843)20-46-81
Ноябрьск (3496)41-32-12
Новосибирск (383)227-86-73
Омск (3812)21-46-40
Орел (4862)44-53-42
Оренбург (3532)37-68-04
Пенза (8412)22-31-16
Петрозаводск (8142)55-98-37
Псков (8112)59-10-37
Пермь (342)205-81-47

Ростов-на-Дону (863)308-18-15
Рязань (4912)46-61-64
Самара (846)206-03-16
Санкт-Петербург (812)309-46-40
Саратов (845)249-38-78
Севастополь (8692)22-31-93
Саранск (8342)22-96-24
Симферополь (3652)67-13-56
Смоленск (4812)29-41-54
Сочи (862)225-72-31
Ставрополь (8652)20-65-13
Сургут (3462)77-98-35
Сыктывкар (8212)25-95-17
Тамбов (4752)50-40-97
Тверь (4822)63-31-35

Тольятти (8482)63-91-07
Томск (3822)98-41-53
Тула (4872)33-79-87
Тюмень (3452)66-21-18
Ульяновск (8422)24-23-59
Улан-Удэ (3012)59-97-51
Уфа (347)229-48-12
Хабаровск (4212)92-98-04
Чебоксары (8352)28-53-07
Челябинск (351)202-03-61
Череповец (8202)49-02-64
Чита (3022)38-34-83
Якутск (4112)23-90-97
Ярославль (4852)69-52-93

Россия +7(495)268-04-70

Казахстан +7(7172)727-132

Киргизия +996(312)96-26-47

<https://amiad.nt-rt.ru> || afv@nt-rt.ru